

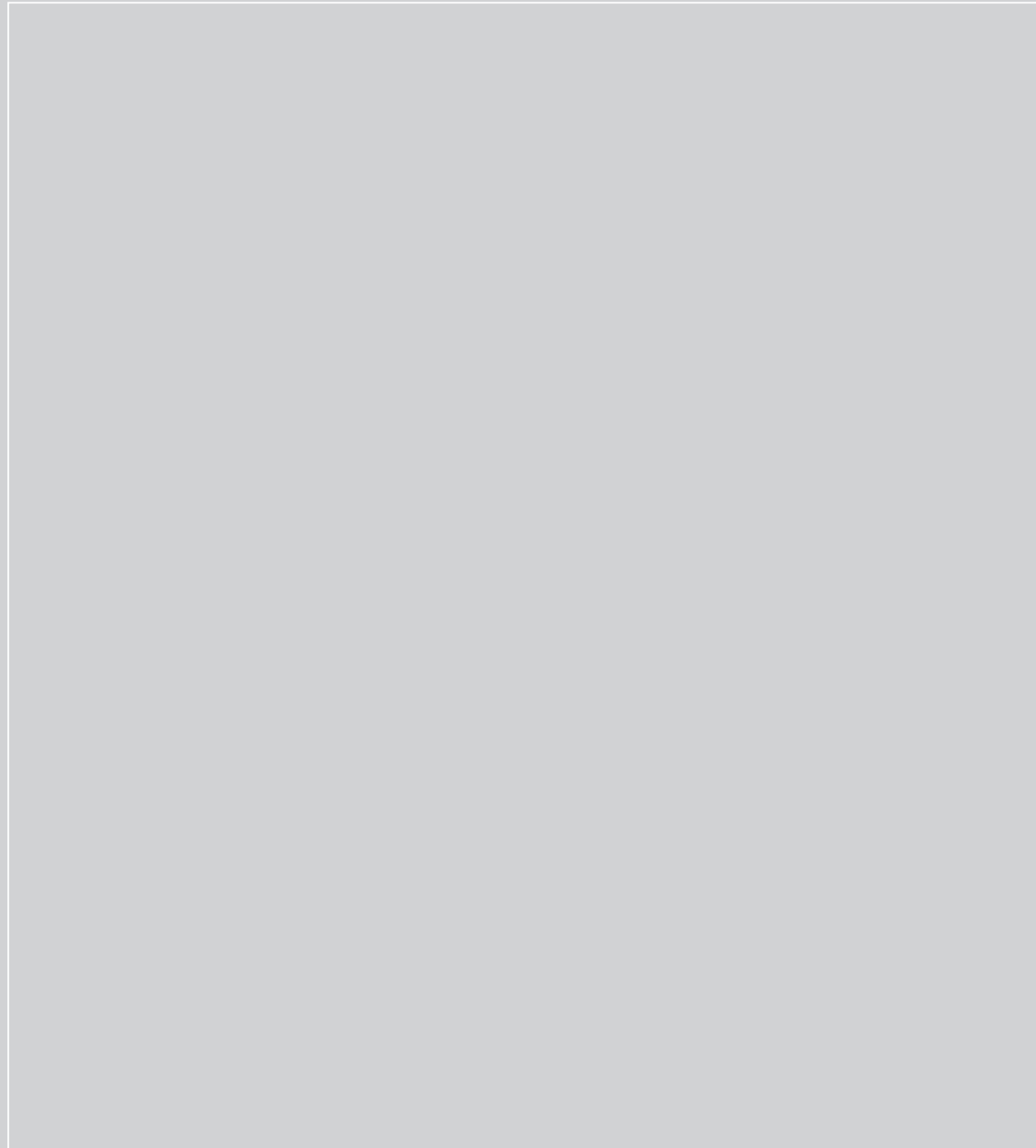

特约省份一级经销：
Provincial initial distributors



2015 西式桌面用品 Western style tableware







本廠創建於1965年并在香港開始制作金銀器餐具產品，由傳統的純手工打制發展為集現代電子機械設備、激光科技設備于一身的現代化企業。嚴謹的表面電鍍工藝處理成就每一件金銀器餐具，高品質的產品享譽酒店管理公司及海內外中東皇室貴族認可。

SCG 研制的自助餐產品可提供無數可能的創意去展示食物的吸引力和高度可靈活搭配，創造檔次與無限空間。在研發過程中，*SCG* 非常注重自助餐產品的兼容性，每個產品的線條，外觀兼具創意與構思。

SCG 秉承創新精神，將傳統和創意相結合，將盡最大的努力把“華麗”和“光亮”帶到餐桌與藝術主題的自助餐空間裏。更使 *SCG* 的品牌成為行業之最。

Our company founded in 1965 in Hongkong, from the manual manufacture of the technicians of the old generation in the beginning to fully mechanized plunger to day, from processing of manufactured body in the beginning to the productive enterprise entity in integrating manufacture, production, surface-electroplating processing, development & research and marketing into itself, manufacturing professionally the gold and silver tableware and buffetware. specialized in making silver wares and stainless steel buffetwares.

SCG offers innumerable possibilities to present food optially appealing and highly flexible, provides level and freedom. When developing mew products ,it is of high importance *SCG* to considerate the compatibility among the individual systems. All products consist of creativities and concepts .

Tradition and creativity combined ,it gives us creativity and flexibility .We will continue to make all efforts to bring "gorgeous" and "shiny" to the dining tables and "art buffet ".



长期合作伙伴 Reference





中餐镀金镀银桌面系列: 秉承“品质才是硬道理”的理念, SCC 始终坚持独立生产, 严格把关每一道工序。胚身原料选用铜或不锈钢 304, 表面电镀处理, 镀金镀银选用西德金盐、银盐及瑞士纯银条, 镀银厚度可达到 3-20 微米。致力于开发适合中西式国宴的高档金银器餐具, 并将中国特色的餐饮文化发扬光大。

Chinese Gold/Silver Plated Tableware Series: We insist the concept of Quality is top priority. Each process from the raw material to finished products is completed by ourselves independently. The raw material is copper or stainless steel 304(18/10), surface can be gold/silver plated. The silvering are selected from the sodium gold chloride and silver salt of West Germany, the thickness can reach 3 to 20 micron. We try our best to produce the deluxe golden and silver tableware, and carry forward Chinese catering culture.

自助餐主题摆件系列: 随性但彰显着个性、环境融合创意、美观却不乏视觉的冲击。这就是 SCC 自助餐主题元素的精髓所在。纯手工制作让产品更富有无尽的活力, 厚实的材料质感让你感受到自身的尊贵, 而你不经意的摆设, 却可能换来不一样的主题风格, 让你在惊讶中更富有满足感, 这也是 SCC 产品一直的追求。

Buffet Theme Decoration Series: Specific, creativity, the sense of artistic, that are what this series manifest. Manual production brings products endless vitality. Material texture makes you feel dignity. Different ways of decoration can change to other theme styles. Making your life diversified, that is the pursuit of SCC.



西餐桌面系列: 凭借严谨的工艺、精湛的技术和一流的创意, SCC 将简约、时尚、浪漫、高贵的特质发挥得淋漓尽致。产品经过冲压、烧焊、外表采用反复数次的镜面抛光、打磨等几十道严格工艺工作, 为消费者提供最佳的使用效果, SCC 产品是享受美食的最佳伴侣, 充分体现美食配美器的理念。

Western Style Tableware Series : With strict technology and first-class creative, exquisite technology, SCC describes the characteristic of simple, fashionable, romantic and noble fully. We provide perfect products for customers after stamping, welding, mirror polishing, grinding and other dozens of strict process. SCC is the best partners to enjoy food. Our concept is "delicious food must be with wonderful tableware".



中东皇家摆台系列: 为中东皇室度身定制的镀金镀银系列产品, 产品特性彰显中东地区特色文化, 电镀 24K 金包裹着的外观沿袭了中东的大气奢华之风, 在婚礼、宴会上广受欢迎, 深得各经销商及酒店的青睐。

Aristocratic Table Decoration Series with characteristic Middle East manner. The Gold plated and silver plated series, customized for royals, manifests distinct culture of the Middle East. 24k gold plated surface Inherits luxurious, also exquisite style. Their popularity in weddings and banquets wins the deep favor of dealers and hotels.

礼品家饰系列: 品质决定价值, 而 SGG 礼品系列工艺的精髓雕琢, 融合国际一流的设计大师理念, 产品的金银电镀厚度达到 3-20 微米不等, 使产品价值提升到一定的层次, 让产品实用性和收藏性融合升华。SGG 礼品是送礼、收藏的首选!

Gift Decoration Series. Value lies in Quality. SCC gifts enjoy excelsior craft, especially the integration of first class international design concept. Moreover, The gold or silver electroplating thickness reaches a range of 3µm to 20µm. SCC are first choice for gift giving and collecting.



镀金



镀银



Room Items Wood Series

客房沐浴用品系列: 我们将 SGG 客房用品的原木材经过严谨的手工制作, 结合优质的 304 不锈钢, 设计了一系列的实用、时尚和高贵的客房用品, 还有来自巴黎风格的一次性客房用品系列, 不仅让您忘却出差、旅游的疲惫, 而且仿如置身于充满香薰沐浴的大自然当中, 令人心旷神怡。



Room and bath Amenities: The logs of SGG room amenities is deal with environmental paint, with the superior stainless stell 304, we designed many series of practical fashion and noble room amenities. And the Paris style disposable goods not only make you forget the exhaustion from the business trip and travel, but also relax and happy into the nature filled with aromatherapy. gift giving and collecting.



目 录
CONTENTS

温馨提示

金银器产品护理，切勿用带酸性或碱性的清洁剂擦洗，只需用温水加中性优质洗洁精清洗，再用清水洗干净。

因产品不断更新改良，如本目录产品与实物尺寸有出入时，敬请以实物为准。



刀叉 Flatware
P010~014



西餐盖 / 碟 Dome/plate
P015~018



牛油碟 Butter cooler
P019~019



咖啡壶 Coffee pot
P020~028



味料瓶 Seasoning bottle set
P029~033



果仁兜 Bar-relish dish
P024~035



果酱架 Jam stand
P036~037



面包篮 Bread basket
P038~039



下午茶系列 High-tea series
P040~046



鸟笼展示架 Pastry stand
P047~050



酒桶 / 架 Wine buckets
P058~059



水扎 / 酒架
Pitcher/wine Cradle
P060~065



烛台 Candlestand
P066~071



台号座 Table number stand
P072~077

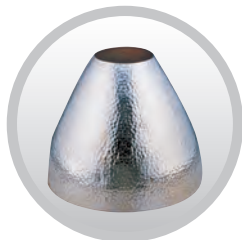

花瓶 Vase
P078~079



巾圈 Napkin ring
P080~082

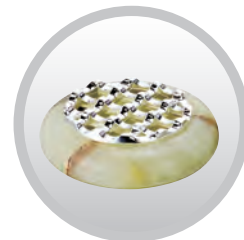

烟灰 Ashtray
P083~084



杯托 Cup stand
P084~085

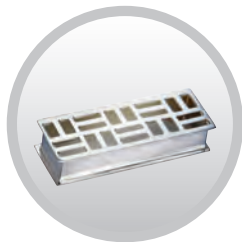

牙签盒 Toothpick-holder
P085

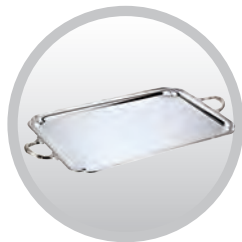

服务托盘 Service tray
P086~089

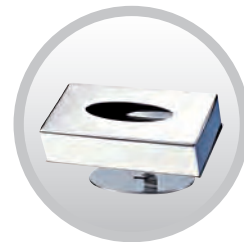

纸巾盒 Tissue box
P090~092

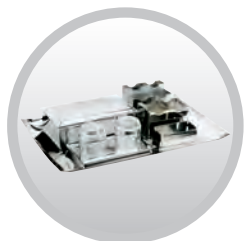

客房用品 Room items
P093~103



淋浴用品 Bath amenities
P104~105



客房用品 Appliance series
P106































煲 Pot
P107







型号 Code	产品名称 Article	规格 Size
	NO:5001A 主餐刀 Table knife	L250mm
	NO:5001B 牛扒刀 Steak knife	L235mm
	NO:5001C 甜品刀 Dessert knife	L228mm
	NO:5001D 魚刀 Fish knife	L203mm
	NO:5001E 牛油刀 Butter knife	L170mm
	NO:5001F 服務更 Service spoon	L270mm
	NO:5001G 沙律更 Salad spoon	L205mm
	NO:5001H 沙律叉 Salad fork	L205mm
	NO:5001I 分更 Serving spoon small	L200mm
	NO:5001J 湯更 Soup spoon	L190mm
	NO:5001K 主餐更 Table spoon	L218mm
	NO:5001L 甜品更 Dessert spoon	L198mm
	NO:5001M 冰更 Ice spoon	L200mm
	NO:5001N 茶更 Tea spoon	L150mm
	NO:5001O 雪糕更 Ice cream spoon	L135mm
	NO:5001P 咖啡更 Coffee spoon	L110mm
	NO:5001Q 服務叉 Service fork	L255mm
	NO:5001R 主餐叉 Table fork	L210mm
	NO:5001S 分叉 Serving for small	L210mm
	NO:5001T 魚叉 Fish fork	L195mm
	NO:5001U 甜品叉 Dessert fork	L187mm
	NO:5001V 餅叉 Cake fork	L155mm
	NO:5001W 蚌叉 Oyster fork	L136mm
	NO:5001X 水果叉 Fruit fork	L155mm
	NO:5001Y 餅鏟 Cake server	L248mm
	NO:5001Z 大湯勺 Big spoon	L280mm
	NO:5001Z1 小湯勺 Small spoon	L185mm
	NO:5001Z2 水果刀 Fruit knife	L170mm





NO:5002
刀叉架 Flatware stand
L90xW62xH30mm



型号 Code	产品名称 Article	规格 Size
NO:5002A	主餐刀 Table knife	L235mm
NO:5002B	牛扒刀 Steak knife	L220mm
NO:5002C	甜品刀 Dessert knife	L210mm
NO:5002D	鱼刀 Fish knife	L206mm
NO:5002E	牛油刀 Butter knife	L182mm
NO:5002F	服务更 Service spoon	L250mm
NO:5002G	沙律更 Salad spoon	L215mm
NO:5002H	沙律叉 Salad fork	L215mm
NO:5002I	分更 Serving spoon small	L210mm
NO:5002J	汤更 Soup spoon	L180mm
NO:5002K	主餐更 Table spoon	L215mm
NO:5002L	甜品更 Dessert spoon	L195mm
NO:5002M	冰更 Ice spoon	L200mm
NO:5002N	茶更 Tea spoon	L155mm
NO:5002O	雪糕更 Ice cream spoon	L150mm
NO:5002P	咖啡更 Coffee spoon	L118mm
NO:5002Q	服务叉 Service fork	L250mm
NO:5002R	主餐叉 Table fork	L215mm
NO:5002S	分叉 Serving for small	L220mm
NO:5002T	鱼叉 Fish fork	L200mm
NO:5002U	甜品叉 Dessert fork	L188mm
NO:5002V	饼叉 Cake fork	L160mm
NO:5002W	蚝叉 Oyster fork	L140mm
NO:5002X	水果叉 Fruit fork	L160mm
NO:5002Y	饼鏟 Cake server	L180mm
NO:5002Z	大汤勺 Big spoon	L280mm
NO:5002Z1	小汤勺 Small spoon	L198mm
NO:5002Z2	水果刀 Fruit knife	L180mm



■ **NO:5003**
刀叉架 Flatware stand
L90xW62xH30mm

型号 Code	产品名称 Article	规格 Size
NO:5003A	主餐刀 Table knife	L235mm
NO:5003B	牛扒刀 Steak knife	L220mm
NO:5003C	甜品刀 Dessert knife	L210mm
NO:5003D	魚刀 Fish knife	L206mm
NO:5003E	牛油刀 Butter knife	L182mm
NO:5003F	服務更 Service spoon	L250mm
NO:5003G	沙律更 Salad spoon	L215mm
NO:5003H	沙律叉 Salad fork	L215mm
NO:5003I	分更 Serving spoon small	L210mm
NO:5003J	湯更 Soup spoon	L180mm
NO:5003K	主餐更 Table spoon	L215mm
NO:5003L	甜品更 Dessert spoon	L195mm
NO:5003M	冰更 Ice spoon	L200mm
NO:5003N	茶更 Tea spoon	L155mm
NO:5003O	雪糕更 Ice cream spoon	L150mm
NO:5003P	咖啡更 Coffee spoon	L118mm
NO:5003Q	服務叉 Service fork	L250mm
NO:5003R	主餐叉 Table fork	L215mm
NO:5003S	分叉 Serving for small	L220mm
NO:5003T	魚叉 Fish fork	L200mm
NO:5003U	甜品叉 Dessert fork	L188mm
NO:5003V	餅叉 Cake fork	L160mm
NO:5003W	蚝叉 Oyster fork	L140mm
NO:5003X	水果叉 Fruit fork	L160mm
NO:5003Y	餅鏟 Cake server	L180mm
NO:5003Z	大湯勺 Big spoon	L280mm
NO:5003Z1	小湯勺 Small spoon	L198mm
NO:5003Z2	水果刀 Fruit knife	L180mm





型号 Code	产品名称 Article	规格 Size
NO:5004A	主餐刀 Table knife	L235mm
NO:5004B	牛扒刀 Steak knife	L245mm
NO:5004C	甜品刀 Dessert knife	L205mm
NO:5004D	魚刀 Fish knife	L200mm
NO:5004E	牛油刀 Butter knife	L185mm
NO:5004F	服務更 Service spoon	L 250mm
NO:5004G	沙律更 Salad spoon	L230mm
NO:5004H	沙律叉 Salad fork	L230mm
NO:5004I	分更 Serving spoon small	L195mm
NO:5004J	湯更 Soup spoon	L175mm
NO:5004K	主餐更 Table spoon	L205mm
NO:5004L	甜品更 Dessert spoon	L180mm
NO:5004M	冰更 Ice spoon	L 200mm
NO:5004N	茶更 Tea spoon	L140mm
NO:5004O	雪糕更 Ice cream spoon	L140mm
NO:5004P	咖啡更 Coffee spoon	L113mm
NO:5004Q	服務叉 Service fork	L250 mm
NO:5004R	主餐叉 Table fork	L205mm
NO:5004S	分叉 Serving for small	L206mm
NO:5004T	魚叉 Fish fork	L183mm
NO:5004U	甜品叉 Dessert fork	L183mm
NO:5004V	餅叉 Cake fork	L148mm
NO:5004W	蚌叉 Oyster fork	L135mm
NO:5004X	水果叉 Fruit fork	L157mm
NO:5004Y	餅鏟 Cake server	L248mm
NO:5004Z	大湯勺 Big spoon	L280mm
NO:5004Z1	小湯勺 Small spoon	L182mm
NO:5004Z2	水果刀 Fruit knife	L180mm







■ **NO:187A**
龍紋圓頂西餐碟蓋
Dragon dome
A: ϕ 220xH130mm
B: ϕ 265xH175mm
C: ϕ 310xH180mm



■ **NO:121E**
龍鳳加命邊席面碟
Gallon plate
10": 外 ϕ 255x內 ϕ 190mm
12": 外 ϕ 300x內 ϕ 260mm



■ **NO:187C**
夢巴黎錘印圓頂餐碟蓋
Paris dome
8" ϕ 220xH130mm
10" ϕ 265xH175mm
12" ϕ 310xH180mm



■ **NO:186B1**
夢巴黎錘印席面碟
Paris plate
 ϕ 331x ϕ 248mm
 ϕ 180x ϕ 138mm



■ **NO:187E**
豪爵圓頂光身餐碟蓋
Roger mirror dome
A: ϕ 220xH130mm
B: ϕ 265xH175mm
C: ϕ 310xH180mm



■ **NO:186C1**
豪爵席面碟
Roger plate
L300x ϕ 205mm
L200x ϕ 160mm



■ **NO:187F**
豪爵錘點圓頂餐碟蓋
Roger hammered dome
A: ϕ 220xH130mm
B: ϕ 265xH175mm
C: ϕ 310xH180mm



■ **NO:186E1**
錘點席面碟
Hammered plate
 ϕ 310x ϕ 210mm
 ϕ 226x ϕ 160mm



■ **NO:187L**
 溫莎圓頂光身餐碟蓋
 Windsor dome
 A: ϕ 220xH130mm
 B: ϕ 265xH175mm
 C: ϕ 310xH180mm



■ **NO:186D1**
 溫莎席面碟
 Windsor plate
 ϕ 310x ϕ 210mm
 ϕ 226x ϕ 160mm



■ **NO:187I**
 伯爵餐蓋 Count dome
 10.5" ϕ 265xH160mm



■ **NO:187II**
 伯爵餐碟 Count plate
 ϕ 350mm



■ **NO:187J**
 公爵餐蓋 Duke dome
 12.5" ϕ 316xH170mm



■ **NO:187J1**
 公爵餐碟 Duke plate
 12.5" ϕ 320x ϕ 210mm
 18" ϕ 455x ϕ 295mm



■ **NO:187K**
 通花餐蓋 Hollow dome
 11" ϕ 280xH145mm
 12.5" ϕ 316xH165mm



■ **NO:187K1**
 通花圓形碟 Hollow plate
 9" ϕ 230x ϕ 155mm
 14" ϕ 355x ϕ 210mm
 14.5" ϕ 370x ϕ 250mm
 18" ϕ 460x ϕ 300mm



■ NO:187M
皇朝餐蓋 Dynasty dome
φ 275xH220mm



■ NO:187N
花蕾餐蓋 Flower bud dome
φ 275xH220mm



■ NO:187O
羅馬餐蓋 Rome dome
φ 275xH220 mm

可选配盖顶
Knob series



187P1



187P2



187P3



187P4



187P5



187P6



187P7



187P8



■ NO:187M1
皇朝餐碟 Dynasty plate
φ 385mm



■ NO:187N1
花蕾餐碟 Flower bud plate
φ 385mm



■ NO:187O1
羅馬餐碟 Rome plate
φ 385mm



■ NO:N-111
錘印席面碟 Hammered plate
φ 330mm



牛油盅
Butter cooler

魚子醬盅
caviar cooler



■ NO:202F1
牛油碟連蓋
Butter cooler cover
φ 72x H60mm



■ NO:202F2
牛油碟連蓋
Butter cooler cover
φ 72x H60mm



■ NO:202G1
魚子醬盅 Caviar jar
蓋 φ 75mm
杯 φ 70x H75mm



■ NO:202G2
魚子醬盅 Caviar jar
φ 140mm



■ NO:202F3
牛油碟連蓋
Butter cooler cover
φ 72x H60mm



■ NO:202F4
牛油碟連蓋
Butter cooler cover
φ 72x H60mm



■ NO:202G3
魚子醬盅 Caviar jar
蓋 φ 75mm
杯 φ 70x H75mm



■ NO:202G4
魚子醬盅 Caviar jar
φ 140mm



■ NO:202F5
牛油碟連蓋
Butter cooler cover
φ 80x H70mm



■ NO:202F6
牛油碟連蓋
Butter cooler cover
φ 80x H70mm



■ NO:202G5
魚子醬盅 Caviar jar
蓋 φ 75mm
杯 φ 70x H75mm



■ NO:202G6
魚子醬盅 Caviar jar
φ 140mm



■ NO:R-107A
茶格連座 Tea strainer with stand
φ 62xH140mm



■ NO:R-107B
茶格連座 Tea strainer with stand
φ 62xH140mm



■ NO:R-107C
牛油碟 Butter cooler
φ 105mm





特征:

1. 原材料: 不锈钢 304
2. 壶身厚度: 1.5mm
3. 配件: 精铸
4. 电镀厚度: 可按客户指定要求 5-20 微米的厚度生产
5. 外观设计: 符合人性设计, 优雅高贵
6. 挽手: 独特的防传热设计
7. 防止滴漏的壶嘴设计

Specification:

1. Raw material: Stainless steel 304
2. Pot body thickness: 1.5mm
3. Accessories: Precision casting
4. Plated thickness: 10 to 20 micron
5. External design: humanization design, elegant and noble
6. Handle: exclusive heat resistance design
7. Non-dripping spout



■ **NO:5005A**
水壺 Water pitcher
160ml:L220xH205mm



■ **NO:5005B**
奶壺 Milk pot
900ml:L200xH230mm
500ml:L175xH195mm
250ml:L150xH155mm



■ **NO:5005C**
咖啡壺 Coffee pot
900ml:L200xH230mm
500ml:L175xH195mm
250ml:L150xH155mm



■ **NO:5005D**
茶壺 Teapot
600ml:L200xH185mm
350ml:L160xH155mm



■ **NO:5005E**
奶盅 Creamer
450ml:L150xH140mm
300ml:L125xH115mm
175ml:L110xH90mm



■ **NO:5005F**
糖盅 Sugar pot
225ml:L115xH135mm

产品搭配組合



■ **NO:5005G**
奶糖組合 Creamer and sugar set
糖缸:L80xW80xH80mm
奶盅:L125xH115mm
底碟:L172xW8.5xH8mm



■ **NO:5005H**
奶糖組合 Creamer and sugar set
糖缸:φ 65xL90xH60mm
奶盅:L125xH115mm
底碟:L172xW8.5xH8mm



■ **NO:5005I**
奶糖組合 Creamer and sugar set
糖缸:L115xH135mm
奶盅:L125xH115mm
底碟:L172xW8.5xH8mm
糖夾:L80mm



■ **NO:5005J**
啡奶糖組合 Coffee, Creamer and sugar set
咖啡壺:L150xH155mm
奶盅:L125xH115mm
底碟:L300xW12xH8mm



■ NO:5005L1
展示架 Teapot stand
φ 184x φ 184xH285mm



L2



L3



■ NO:M-137
點心架 Cake stand
I340xH400mm



■ NO:5005K1
展示架 Bar-relish stand
L243xW243xH274mm



■ NO:5005K2
展示架 Bar-relish stand
243xW243xH274mm



■ NO:5005K3
展示架 Bar-relish stand
L243xW243xH370mm



■ NO:5005K4
展示架 Bar-relish stand
L243xW243xH370mm



■ NO:5005N
醬料瓶架 Dispenser bottle set
φ 190xH240mm



■ NO:5005O
果仁架 Bar-relish stand
φ 200xH190mm



■ NO:5005P
果仁架 Bar-relish stand
φ 200xH85mm





■ NO:5006A
水壺 Water pitcher
1800ml



■ NO:5006B
咖啡壺 Coffee pot
800ml



造型独特，优雅高贵
手柄防传热设计

■ NO:5006C
茶壺 Teapot
700ml



■ NO:5006D
奶盅 Creamer
200ml



■ NO:5006E
糖盅 Sugar pot
250ml



■ NO:5006F
奶糖組合 Creamer and sugar set
糖缸:L115xH135mm
奶盅:L125xH115mm
底碟:L172xW8.5xH8mm



■ NO:5006G
奶糖組合 Creamer and sugar set
糖缸:L80xW80xH80mm
奶盅:L125xH115mm
底碟:L172xW8.5xH8mm



■ HNO:5006H
奶糖組合 Creamer and sugar set
糖缸:φ 65xL90xH60mm
奶盅:L125xH115mm
底碟:L172xW8.5xH8mm
糖夾:L80mm



■ NO:50061
展示架 Seasoning jar set
φ 184xφ 184xH285mm



13



■ NO:5006L
醬料瓶架 Dispenser bottle set
φ 190xH240mm



■ NO:5006K1
展示架 Jar stand
L243xW243xH274mm



■ NO:5006K2
展示架 Jar stand
L243xW243xH274mm



■ NO:5006K3
展示架 Jar stand
L243xW243xH370mm



■ NO:5006K2
展示架 Jar stand
L243xW243xH370mm



■ NO:5006M
果仁架 Bar-relish dish
φ 200xH190mm



■ NO:5006N
果仁架 Bar-relish dish
φ 200xH85mm



■ NO:M-138
點心架 Cake stand
L280xH550mm



■ **NO:M-103**
咖啡壺 Coffee pot
L180xW80xH195mm
450ml



■ **NO:M-137**
茶壺 Teapot
L160xW80xH195mm
450ml



■ **NO:M-138**
奶盅 Creamer pot
L92xW45xH92mm
135ml



■ **NO:M-139**
糖盅 Sugar pot
L115xW67xH63mm
135ml



■ **NO:M-101**
奶盅 Milk pot
L55xW38xH38mm
25ml

■ **NO:M-102**
吧更 Bar spoon
L210mm



■ **NO:5007A**
奶糖組合 Creamer and sugar set
糖缸:L80xW80xH80mm
奶盅:L125xH115mm
底碟:L172xW8.5xH8mm



■ **NO:5007B**
奶糖組合 Creamer and sugar set
糖缸:φ65xL90xH60mm
奶盅:L125xH115mm
底碟:L172xW8.5xH8mm



■ NO:5008A
水壺 Water pitcher
1750ml



■ NO:5008B
咖啡壺 Coffee pot
A:350ml
B:600ml
C:900ml



■ NO:5008C
茶壺 Teapot
A:350ml
B:600ml
C:900ml



■ NO:5008D
糖盅 Sugar pot
350ml



■ NO:5008E
奶壺 Milk pot
A:150ml
B:350ml



■ NO:5008G
咖啡組合 Creamer and sugar set
底碟:L172xW8.5xH8mm

調味組合系列 Flavour series



■ NO:204A
胡椒瓶/鹽瓶
Pepper/salt bottle
φ 38xH82mm



■ NO:204B
胡椒瓶/鹽瓶
Pepper/salt bottle
φ 47xH75mm



■ NO:204C1
味料瓶架 Salt/pepper set
瓶 φ 35xH90mm
架 L10xW40xH180mm



■ NO:204C2
味料瓶架 Salt/pepper set
瓶 φ 35xH100mm
架 L102xH173mm



■ NO:204C3
調味瓶組合 Flavour series
H135mm



■ NO:204C4
味料瓶架 Seasoning bottle
φ 50xH160mm



■ NO:204C5
味料瓶架 Seasoning bottle
φ 50xH180mm



■ NO:204C6
胡椒磨 Pepper mill
φ 52xH320mm



■ NO:204C7
胡椒瓶/鹽瓶
Pepper/salt bottle
L180xW45xH50mm



■ NO:204D1
 味料瓶架 Salt/pepper set
 瓶 L25xW25xH30mm
 架 L120xW70XH150mm



■ NO:204D2
 味料瓶架 Salt/pepper set
 瓶 L30xW30xH30mm
 架 L120xW70XH150mm



■ NO:204D3
 味料瓶架 Salt/pepper set
 瓶 L30xH30mm
 架 L120xW70XH150mm



■ NO:204D4
 味料瓶架 Salt/pepper set
 瓶 ϕ 30mm
 架 L120xW70XH150mm



■ NO:204E1
 味料瓶架 Dispenser bottle set
 瓶 ϕ 60xH180mm
 架 L170xW80XH250mm



■ NO:204E2
 味料瓶架 Dispenser bottle set
 大瓶 ϕ 35xH180mm
 小瓶 ϕ 25xH180mm
 架 ϕ 110XH250mm



■ NO:204E3
 味料瓶架 Dispenser bottle set
 瓶 ϕ 60xH180mm
 架 L170xW80XH250mm



■ NO:204E4
 味料瓶架 Dispenser bottle set
 大瓶 ϕ 60xH180mm
 小瓶 ϕ 35xH90mm
 架 L220xW150xH230mm



■ NO:201F
 魚形醬汁架
 Dipper set
 H100mm



■ NO:201G
 光身醬汁架連玻璃兜
 Dipper set
 H100mm



■ NO:N-121
 S型鐘紋醬汁架連玻璃兜
 Dipper set
 H120mm



■ NO:N-116
 三頭光身醬汁架
 Dipper set
 H100mm



■ NO:N-122
S型光身醬汁架連玻璃兜
Dipper set
H120mm



■ NO:N-119
四頭醬汁架
Dipper set
W138xH99mm



■ NO:N-120
三頭醬汁架連玻璃兜
Dipper set
W138xH99mm



■ NO:202C2
汁船 Gravy boat
大:L155xH85mm
中:L140xH58mm
小:L120xH40mm



■ NO:202C3
汁船 Gravy boat
大:L155xH85mm
中:L140xH58mm
小:L120xH40mm



■ NO:204F1
味料瓶架 Seasoning jar set
瓶 ϕ 65xH110mm
底 L170xH160mm
更L160mm



■ NO:N-124
四兜醬汁架Dipper set
W300xH80mm



■ NO:N-125
三兜醬汁架 Dipper set
W231xH80mm



■ NO:204F2
味料瓶架 Seasoning jar set
L243xW243xH370mm



■ NO:204F3
醬料架 Seasoning jar set
瓶 ϕ 65xH110mm
架 L380xW95xH45mm



■ NO:204F4
醬料架 Seasoning jar set
瓶 L83xW83xH20mm
架 L455xW120xH45mm



■ NO:204F5
醬料架 Seasoning jar set
碟 L295xW105xH20mm
杯 L60xW60xH30mm

調味組合系列 Flavour series

牙籤盒
A Toothpick or



■ NO:204G2
味料瓶架連牙籤盒 Flavour & toothpick set
瓶 ϕ 35xH90mm
底座 L135xH135mm



■ NO:204G3
味料瓶架 Seasoning set
L300xW200xH70mm



■ NO:204H1
小吃架 Bar-relish dish
L205xW62xH317mm



■ NO:204H2
味料瓶架 Seasoning set
L145xW145xH254mm



■ NO:204H3
味料瓶架 Seasoning set
L145xW145xH254mm



■ NO:204H4
味料瓶架 Jar stand
L145xW145xH254mm





■ NO:P-134
花瓶 Vase
L80xW80xH235mm



■ NO:P-135
花瓶 Vase
L45xW45xH160mm



■ NO:N-140
醬汁架連匙 Dipper set
L130xW130xH190mm



■ NO:M-139
面包架 Bread basket
L245xW200xH90mm



■ NO:M-140
小食架 Snack stand
A: ϕ 115xH390mm
B: ϕ 130xH475mm



■ NO:M-141
點心架 Cake
L450xW260xH380mm



果仁架系列 *Bar-relish dish series*



■ NO:201A1
帶蓋果仁盒 Bar-relish bowl with cover
φ 117xH94mm



■ NO:201A2
果仁盒 Bar-relish bowl
φ 117xH94mm



■ NO:201A3
果仁架 Bar-relish dish
φ 200xW200xH90mm



■ NO:201A4
果仁架 Bar-relish dish
φ 225xW225xH35mm



■ NO201A5
果仁架 Bar-relish dish
φ 80xH110mm



■ **NO:201A6**
果仁架 Bar-relish dish
W200xH120mm



■ **NO:201A7**
果仁架 Bar-relish dish
W190xH190mm



■ **NO:N-123**
三頭果仁架 Bar-relish dish
W100xH200mm



■ **NO:201B1**
彎形果仁盒連架
Bar-relish dish
W192xH212mm



■ **NO:201B2**
果仁架 Bar-relish dish
φ 200xW200xH280mm
φ 200xW200xH230mm
φ 200xW200xH170mm



■ **NO:201B3**
果仁架 Bar-relish dish
φ 200xW200xH230mm



■ **NO:201C**
直身果仁盒連架
Bar-relish dish
W161xH260mm



■ **NO:201D**
三頭果仁架
Bar-relish dish
W161xH220mm



■ **NO:M-136**
展示座 Bar-relish dish
L330xW95xH180mm

咖啡伴侣系列 *Coffee sets series*



■ NO:5009A
奶茶/咖啡組合
Milk tea and coffee sets



■ NO:5009B
奶茶/咖啡組合
Milk tea and coffee sets



■ NO:5009C
奶茶/咖啡組合
Milk tea and coffee sets



■ NO:5009D
奶茶/咖啡組合
Milk tea and coffee sets



■ NO:5009E
奶茶/咖啡組合
Milk tea and coffee sets



■ NO:5009F
奶茶/咖啡組合
Milk tea and coffee sets



■ NO:5009G
奶茶/咖啡組合
Milk tea and coffee sets



■ NO:5009H
奶茶/咖啡組合
Milk tea and coffee sets



■ NO:5009I
奶茶/咖啡組合
Milk tea and coffee sets



■ NO:5009J
奶茶/咖啡組合
Milk tea and coffee sets





■ NO:5009K
奶茶/咖啡組合
Milk tea and coffee sets



■ NO:5009L
奶茶/咖啡組合
Milk tea and coffee sets



■ NO:5009M
奶茶/咖啡組合
Milk tea and coffee sets



■ NO:5009N
奶茶/咖啡組合
Milk tea and coffee sets



■ NO:5009O
奶茶/咖啡組合
Milk tea and coffee sets



■ NO:5009P
奶茶/咖啡組合
Milk tea and coffee sets



■ NO:5009Q
奶茶/咖啡組合
Milk tea and coffee sets



■ NO:5009R
奶茶/咖啡組合
Milk tea and coffee sets



■ NO:5009S
杯托



■ NO:5009S1
杯托



■ NO:5009S2
杯托



■ NO:5009S3
杯托



■ NO:5009S4
杯托



■ NO:5009T
杯托



■ NO:5009T1
杯托



■ NO:5009T2
杯托



■ NO:5009T3
杯托



■ NO:5009U
托盤 Serving tray



■ NO:5009V
托盤 Serving tray



■ NO:5009W
咖啡更 Coffee spoon

面包籃系列 Bread basket series



■ NO:5010A
糖盒 Sugar box
L203xW75xH75mm



■ NO:5010B
三格糖盒 Sugar box
L203xW75xH75mm



■ NO:5010C
雙格糖盒 Sugar box
L130xW78xH78mm



■ NO:5010D
四格糖盒 Sugar box
L130xW78xH78mm



■ NO:5011A
五頭果醬碟 Jam tray
L180xW51xH10mm



■ NO:5011B
四頭果醬碟 Jam tray
L180xW51xH10mm



■ NO:5011D
果醬架 Jam stand
L135xH185mm



■ NO:5011E
果醬架 Jam stand
L140xH255mm



■ NO:5011C
果醬架 Jam stand
φ100xH240mm



■ NO:5011F
果醬架 Jam stand
L135xH180mm



■ NO:5012A
三頭果仁架 Bar-relish dish set
L184xW184xH285mm



■ NO:5012B
三頭果仁架 Bar-relish dish set
L184xW184xH285mm



■ NO:5012C1
五頭果仁架 Bar-relish dish set
L243xW243xH370mm

面包籃系列 Bread basket series

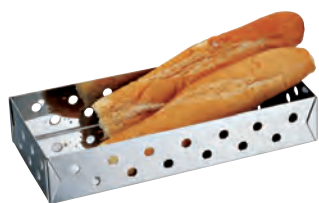

■ NO:H-107
長方形面包籃
Rectangle bread basket
L300xW150xH60mm



■ NO:H-108
正方形面包籃
Square bread basket
L200xW200xH60mm



■ NO:H-109
橢圓形面包籃
Oval bread basket
L320xW145xH60mm



■ NO:213A
蛋形面包籃
Oval bread basket
L275xW195xH67mm



■ NO:213B
圓形面包籃
Round bread basket
φ230xH65mm



■ NO:213C
面包架 bread basket
φ182xH135mm
φ100xH70mm(每位用For each)



■ NO:123A
面包籃 Bread basket
L225xW175xH80mm



■ NO:123B
面包籃 Bread basket
φ200xH80mm



■ NO:213D
多士架 Toast rack
L119xW93xH140mm



■ NO:213D
面包籃 bread basket
L247xW119xH50mm



■ NO:D-198
食物盆 Universal food plate
A:L430xW160xH90mm
B:L715xW225xH100mm



■ NO:H-102A
多士架
Toast rack
L100xH100mm



■ NO:J-122C
食物盆 Universal food plate
B:290xW150xH50mm
C:L200xW105xH55mm



■ NO:J-117B
食物碗 Universal bowl, small
L120xW120xH40mm
L170xW170xH80mm



■ NO:J-124
食物碗 Universal bowl, small
L195xH65mm



■ NO:H-102B
多士架 Toast rack
L235xW140xH150mm





■ NO:123B
點心架 Cake stand
φ 203xH270mm



■ NO:M-142
點心架 2-Tiers cake stand
L285xH340mm



■ NO:M-143
點心架 2-Tiers cake stand
L320xH500mm



■ NO:M-144(ZD9-3)
三層糕點座 2-Tiers cake stand
L310xW115xH370mm



■ NO:M-145
點心架 3-Tiers cake stand
φ 400xH470mm



■ NO:M-114
點心架 3-Tiers cake stand
L150xH300mm



■ NO:M-117
Decorative cake stand
W400xH500mm



■ NO:M-118A
不銹鋼長方形食物展示架
Cake display stand
L280xW100xH380mm



■ NO:M-118
不銹鋼長方形食物展示架
Cake display stand
L280xW100xH410mm





■ **NO:M-119**
不銹鋼橢圓食物展示架
Cake display stand
大:L900xH850mm
小:L330xH415mm



■ **NO:M-115**
不銹鋼圓形食物展示架
Cake display stand
L340xW90xH380mm



■ **NO:M-146**
不銹鋼圓形食物展示架
Cake display stand
φ 335xH400mm

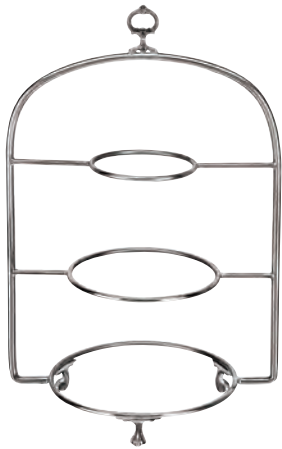

■ **NO:M-128**
三層糕點座 3-Tiers cake stand
W280xH475mm



■ **NO:M-129**
三層糕點座 3-Tiers cake stand
W230xH385mm



■ **NO:M-127**
點心架3-Tiers cake stand
L203xW210xH515mm



■ **NO:M-147**
二層糕點座 2-Tiers cake stand
L266xH450mm



■ **NO:M-148**
三層糕點座 3-Tiers cake stand
大: L280xH470mm
小: L183xH310mm



■ **NO:M-154**
二層糕點座 2-Tiers cake stand
L266xH450mm



■ **NO:M-130**
三層糕點座 3-Tiers cake stand
L340xH430mm



■ **NO:M-152A**
加侖邊三層糕點座 3-Tiers cake stand
L300xH440mm



■ **NO:M-153A**
加侖邊二層糕點座 2-Tiers cake stand
L300xH440mm



■ **NO:M-150**
三層糕點座 3-Tiers cake stand
L295xH445mm



■ **NO:M-152B**
光身三層糕點座 3-Tiers cake stand
L340xH400mm



■ **NO:M-153B**
光身二層糕點座 2-Tiers cake stand
L340xH400mm



■ **NO:M-125**
三層糕點座 3-Tiers cake stand
L340xH360mm



■ **NO:M-151A**
三層糕點座 3-Tiers cake stand
L335xH410mm



■ **NO:M-151B**
二層糕點座 2-Tiers cake stand
L335xH410mm

蛋糕架系列 *Cake stand series*



■ **NO:M-155**
三層糕點座 3-Tiers cake stand
L335xH410mm



■ **NO:M-159**
三層糕點座 3-Tiers cake stand
L280xH455mm



■ **NO:M-160**
二層糕點座 2-Tiers cake stand
L240xH350mm



■ **NO:M-149**
三層糕點座 3-Tiers cake stand
L280xH455mm



■ **NO:M-158**
二層糕點座 2-Tiers cake stand
L310xH455mm



■ **NO:M-135B**
二層糕點座 2-Tiers cake stand
L210xW153xH380mm



■ **NO:M-135C**
三層糕點座 3-Tiers cake stand
L250xW223xH555mm



■ **NO:M-135D**
二層糕點座 2-Tiers cake stand
L300xW203xH515mm



■ **NO:M-156**
三層糕點座 3-Tiers cake stand
H270mm



■ **NO:M-157A**
二層糕點座 2-Tiers cake stand
H180mm



■ **NO:M-157B**
三層糕點座 3-Tiers cake stand
φ216xH312mm



■ **NO:M-157C**
二層糕點座 2-Tiers cake stand
φ221xH221mm
φ220xH162mm



■ **NO:M-157D**
三層糕點座 3-Tiers cake stand
φ215xH320mm



■ **NO:M-157E**
二層糕點座 2-Tiers cake stand
φ224xH215mm
φ223xH160mm

蛋糕架系列 *Cake stand series*



■ NO:H-122
旋轉蛋糕座 Rotating cake stand
φ 320xH60mm



■ NO:H-124
糕點座 Cake stand
φ 300xH100mm



■ NO:M-157F
糕點座 Cake stand
φ 162xH90mm



■ NO:M-134
錘點錐形三層糕點座
Cake stand
φ 115x φ 160x φ 215xH180mm



■ NO:M-135A
錘點錐形三層糕點座
Cake stand
φ 160x φ 250x φ 330xH180mm



■ NO:M-131
二層糕點座 Cake stand
φ 260x φ 325xH330mm



■ NO:M-132
三層糕點座 Cake stand
φ 160x φ 250x φ 330xH420mm





■ NO:M-162
鳥籠糕點座 Cake cage
φ 210xH430mm



■ NO:M-164
鳥籠三層糕點座 Cake cage
φ 210xH430mm



■ NO:M-163
鳥籠二層糕點座 Cake cage
φ 210xH430mm



■ NO:M-165
鳥籠三層糕點座(連架) Cake cage
φ 130xH255mm



可配陶瓷碟/玻璃碟



■ NO:M-166
鳥籠三層糕點座 Cake cage
φ 350xH750mm



■ **NO:M-167**
鳥籠三層糕點座 *Cake cage*
φ 320xH660mm



■ **NO:M-176A**
鳥籠三層糕點座 *Cake cage*
φ 280xH520mm



■ **NO:M-176B**
浴品架/二層糕點座 *Cake cage*
φ 280xH520mm



■ **NO:M-168**
鳥籠糕點座 *Cake cage*
L250xW180xH460mm



■ **NO:M-169**
鳥籠二層糕點座 *Cake cage*
L250xW180xH550mm



■ **NO:M-170**
鳥籠三層糕點座 *Cake cage*
L250xW180xH550mm

蛋糕籠連架系列 *Cake cage with stand series*

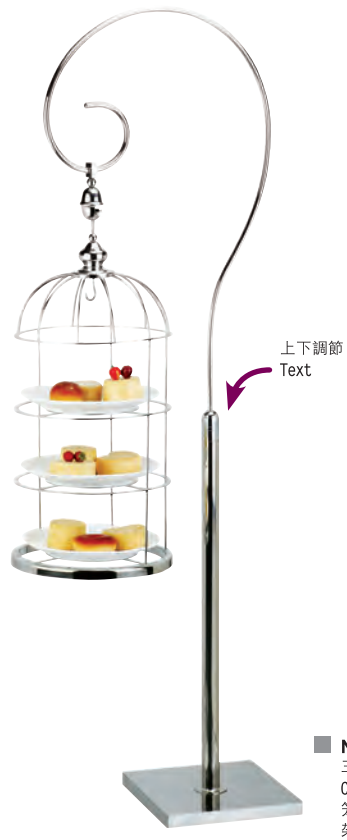

不銹鋼香檳酒桶 / 冰桶系列 Champagne bucket / ice bucket series



■ NO:K-101
酒桶連架
Champagne bucket with stand
L500xW500xH100mm



■ NO:K-102
酒桶連架
Champagne bucket with stand
L500xW500xH100mm

不銹鋼香檳酒桶 / 冰桶系列 *Champagne bucket / ice bucket series*



■ **NO:K-103**
酒桶 Champagne bucket
φ 230xH410mm



■ **NO:K-104**
酒桶 Champagne bucket
桶 φ 220xH330mm



■ **NO:K-106**
酒桶 Champagne bucket
φ 225xH290mm



■ **NO:K-106A**
冰夾
L166mm



■ **NO:K-105**
冰桶 Ice bucket
W150xH180mm



■ **NO:K-107**
冰桶 Ice bucket
L220xW90xH160mm





■ NO:K-108
單層酒桶 Wine bucket
φ 240xH280mm



■ NO:K-109
錘點雙層冰桶 Ice bucket (double wall)
φ 140xH215mm

■ NO:K-109A
冰夾



■ NO:K-110
錘點酒桶 Ice bucket
φ 200xH168mm



■ NO:K-114
雙層酒桶 Wine bucket (double wall)
L195xW195xH205mm



■ NO:K-111
單層酒桶 Wine bucket (single wall)
A:L260xW260xH295mm
B:L200xW200xH230mm
C:L170xW170xH180mm



■ NO:K-112
雙層酒桶 Wine bucket (double wall)
A:L260xW260xH295mm
B:L200xW200xH230mm
C:L170xW170xH180mm



■ NO:K-115
酒桶 Champagne bucket
φ 200x φ 250xH240mm



■ NO:K-116
酒桶 Champagne bucket
φ 200x φ 250xH240mm



■ NO:K-119
酒桶 Champagne bucket
φ 150xH315mm



■ NO:K-120C
酒桶 Champagne bucket
L223xH560 mm



■ NO:K-120A
酒桶 Champagne bucket
φ 330xH800mm



■ NO:K-120B
酒桶 Champagne bucket
φ 330xH800mm



■ NO:K-121
酒桶 Champagne bucket
φ 200xH500mm



■ NO:K-118
酒桶 Champagne bucket
φ 200xH710mm



■ NO:K-125
香檳酒桶 Champagne bucket
φ 178xH192mm



■ NO:K-122
香檳酒座 Champagne bucket
W450xH1200mm



■ NO:K-127
帶蓋香檳酒桶 Champagne bucket
φ 178xH345mm



■ NO:K-126
香檳酒桶 Champagne bucket
φ 178xH220mm



■ NO:K-128
帶蓋香檳酒桶 Champagne bucket
φ 178xH270mm

不銹鋼香檳酒桶 / 冰桶系列 *Champagne bucket / ice bucket series*



■ NO:K-123
29"



■ NO:189A
獅子香檳酒桶 Wine bucket
φ 220xH220mm



■ NO:K-124
酒桶或冰桶 Champagne bucket
7"9"12"

■ NO:K-124A
冰夾



■ NO:189B
獅頭冰桶 Ice bucket
φ 150xH132mm



■ NO:K-129
世紀酒架 Wine stand
φ 435xH685mm



■ NO:189C
皇朝香檳酒桶
Champagne bucket
φ 220xH220mm



■ NO:189D
皇朝冰桶
Ice bucket
φ 145xH132mm



■ NO:189E
三寶香檳酒桶
Champagne bucket
φ 220xH220mm



■ NO:189F
三寶冰桶
Ice bucket
φ 145xH132mm



■ NO:189G
明珠香檳酒桶
Champagne bucket
φ 220xH220mm



■ NO:189H
明珠冰桶
Ice bucket
φ 145xH132mm

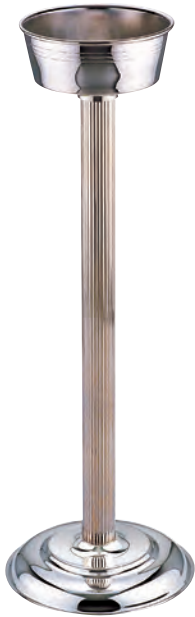

■ NO:K-134
皇朝酒架 Wine stand
φ 190xH630mm



■ NO:K-135
明珠酒架 Wine stand
φ 190xH630mm



■ NO:K-140
三脚酒架 Wine stand
φ 216xH610mm



■ NO:K-141
圓珠三脚冰盤 Punch bowl
A: φ 220xH100mm
B: φ 265xH145mm
C: φ 310xH150mm
D: φ 370xH160mm





■ **NO:K-136**
光身賓治盤 Punch bowl
A: ϕ 220xH135mm
B: ϕ 265xH185mm
C: ϕ 310xH200mm
D: ϕ 370xH230mm



■ **NO:K-138**
錘點賓治盤 Punch bowl
A: ϕ 220xH135mm
B: ϕ 265xH185mm
C: ϕ 310xH200mm
D: ϕ 370xH230mm



■ **NO:K-139A**
錘點冰酒桶 Punch bowl
 ϕ 390xH220mm



■ **NO:K-139B**
冰酒桶 Punch bowl
 ϕ 390xH220mm



■ **NO:D-139**
錘點賓治盤 Punch bowl
A: ϕ 220xH135mm
B: ϕ 265xH185mm
C: ϕ 310xH200mm
D: ϕ 370xH230mm



■ **NO:K-113**
錘點冰酒桶 Champagne bucket
 ϕ 220xH225mm



■ **NO:190G**
錘點冰酒桶 Ice bucket
 ϕ 200xH135mm



■ **NO:D-182**
冰酒盤 Ice bucket
L330xW280xH140mm



■ NO:K-159A
茶/咖啡壺 Tea or coffee pot
φ 90xH195mm



■ NO:K-159B
茶/咖啡壺 Tea or coffee pot
φ 120xH260mm



■ NO:K-151
錘點茶壺 Teapot
φ 140xH160mm



■ NO:K-159D
茶/咖啡壺 Tea or coffee pot
φ 90xH260mm



■ NO:K-159E
茶/咖啡壺 Tea or coffee pot
φ 100xH260mm



■ NO:K-159F
茶/咖啡壺 Tea or coffee pot with strainer
φ 100xH240mm



■ NO:K-161
L120xW70xH230mm



■ NO:K-142
L130xW70xH300mm



■ NO:K-144
90xH300mm



■ NO:K-145
L180xW100xH230mm



■ NO:K-148
φ 90xH300mm



■ NO:K-147
φ 90xH300mm



■ NO:K-146
φ 90xH300mm



■ NO:K-149
φ 100xH280mm



■ NO:K-150
W200xH215mm



■ NO:K-154
φ 105xH210mm



■ NO:K-153
φ 105xH210mm



■ NO:K-143
L125xW100xH210mm



■ NO:K-152
L180xW100xH230mm



■ NO:K-157
φ 100xH230mm



■ NO:K-158
φ 115xH215mm



■ NO:K-160
φ 100xH235mm



■ NO:K-161A
1.0L



■ NO:K-161B
1.5L



■ NO:K-161C
2.0L



杯架系列 Cup stand



■ NO:K-155
L565xW145xH45mm



■ NO:K-156
L340xW100xH40mm



■ **NO:191A**
雙龍酒座 Wine cradle
L280xW105xH134mm

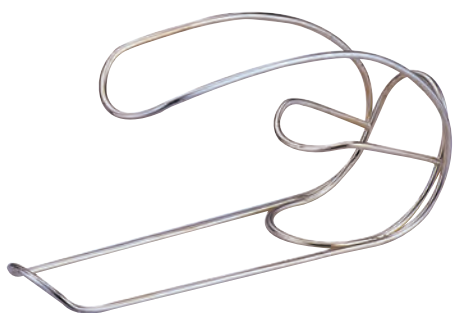

■ **NO:191B**
臥式酒架 Wine cradle
L310xW90xH150mm



■ **NO:191C**
立式酒架 Wine cradle
L180xW60xH220mm



■ **NO:191D**
酒籃 Wine cradle
L245xW90xH250mm





■ NO:N-160
獅頭酒籃 Wine cradle
L260xH190mm



■ NO:N-161
酒架 Wine cradle
φ 190xH220mm



■ NO:N-165
酒架 Wine cradle
W200xH230mm



■ NO:N-166
酒架 Wine cradle
φ 100xH220mm



■ NO:N-167
酒架 Wine cradle
L290xH250mm



■ NO:N-168
彎形酒架 Wine cradle
L257xW100xH265mm





■ NO:P-101
單頭彩石洋燭臺
Candleholder
H216mm



■ NO:P-102
三頭彩石洋燭臺
Stone candleholder
φ 105xL260xH245mm



■ NO:P-103
五頭彩石洋燭臺
Stone candleholder
φ 105xL260xH245mm



■ NO:P-111
單頭花通洋燭臺 Candleholder
H216mm



■ NO:P-104
三頭花通洋燭臺 Candleholder
φ 105xL260xH250mm



■ NO:P-106
五頭花通洋燭臺 Candleholder
φ 105xL260xH250mm



■ NO:P-134
單頭洋燭臺 Candleholder
A:L100xW100xH250mm
B:L100xW100xH250mm
C:L100xW100xH400mm



■ NO:P-135
單頭洋燭臺 Candleholder
A:L100xW100xH300mm
B:L100xW100xH350mm



■ NO:P-120
洋燭臺 Candleholder
L350xH535mm



■ NO:P-117
洋燭臺 Candleholder
L350xH535mm
L254xH307mm



■ **NO:P-114**
三頭洋燭臺 Candleholder
W268xH287mm



■ **NO:P-137**
三頭洋燭臺 Candleholder
L344xH370mm



■ **NO:P-138**
五頭燭臺 Candleholder
L344xH374mm



■ **NO:P-122**
三頭洋燭臺 Candleholder
L330xH310mm



■ **NO:P-139**
三頭洋燭臺 Candleholder
φ80xL255xH190mm



■ **NO:P-115**
三頭洋燭臺 Candleholder
φ90xL130xH270mm



■ **NO:P-123**
三頭洋燭臺 Candleholder
L344xH370mm



■ **NO:P-125**
五頭燭臺 Candleholder
L344xH374mm



■ **NO:P-140**
洋燭臺 Candleholder
L147xW133xH320mm



■ NO:P-112
十五頭燭臺 Candleholder
φ 250xL420xH575mm



■ NO:P-105
豪爵九頭洋燭臺 Candleholder
φ 200xL350xH620mm



■ NO:P-110
夢巴黎九頭洋燭臺 Candleholder
φ 200xL350xH620mm



■ NO:P-109
皇室九頭洋燭臺 Candleholder
W350xH620mm



■ NO:P-108
通花燭臺 Candleholder
W200xH270mm



■ NO:P-107
通花燭臺 Candleholder
W80xH180mm



■ NO:P-141
四頭燭臺 Candleholder
L240xW80xH320mm



■ NO:P-142
單頭燭臺 Candleholder
大: L180xH400mm
中: L180xH300mm
小: L180xH200mm



■ NO:P-143
三頭燭臺 Candleholder
L300xH400mm



■ NO:P-144
五頭燭臺 Candleholder
L300xH400mm



■ NO:P-145
單頭燭臺 Candleholder
L160xW80xH380mm



■ NO:P-146
雙頭燭臺 Candleholder
L180xW80xH390mm



■ NO:P-147
四頭燭臺 Candleholder
L160xH360mm



■ NO:P-148
四頭燭臺 Candleholder
φ200xL237xH420mm



■ NO:P-149
五頭燭臺 Candleholder
φ 150xL370xH400mm



■ NO:P-150
八頭燭臺 Candleholder
φ 330/φ 360xH390mm



■ NO:P-151
雙頭燭臺 Candleholder
L180xW80xH390mm



■ NO:P-121B
八頭燭臺 Candleholder
L420xH287mm





5



■ **NO:L-112**
臺號座
Table number stand
L230xW110xH96mm



■ **NO:L-113**
臺號座
Table number stand
L115xW62xH55mm



■ **NO:L-114**
臺號座
Table number stand
L180xW90xH80mm



■ **NO:L-115**
臺號座
Table number stand
L100xW60xH50mm



■ **NO:L-147**
臺號座
Table number stand
φ 40mm



■ **NO:L-116**
臺號座
Table number stand
H65mm

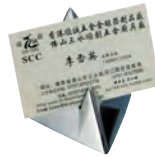

■ **NO:L-134**
臺號座
Table number stand
L100xW65xH65mm



■ **NO:L-123**
臺號座
Table number stand
L90xH60mm
L120xH85mm



■ **NO:L-119**
臺號座
Table number stand
H100mm

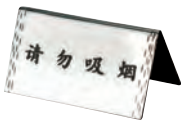

■ **NO:L-122**
禁烟牌
No smoking stand
L100xH53mm

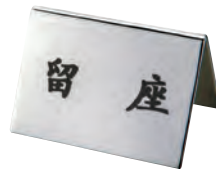

■ **NO:L-124**
留座牌
Reserved stand
L80xH50mm



■ **NO:L-125**
禁烟牌
No smoking stand
L60xH53mm

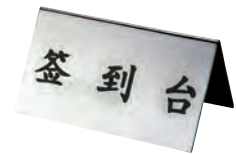

■ **NO:L-126**
簽到牌
Registration stand
L190xH95mm



■ **NO:185A**
臺牌座
Table number stand
L130xW80xH70mm



■ **NO:185B**
臺牌座
Table number stand
L132xW105xH65mm



■ **NO:185C**
臺牌座
Table number stand
L132xW105xH65mm



■ **NO:L-120**
臺號座
Table number stand
φ 90xH70mm



■ **NO:L-121**
臺號座
Table number stand
φ 50xH50mm



■ **NO:L-127**
留臺牌
Reserved stand
L100xH35mm



■ **NO:L-148**
留臺牌
Reserved stand
L300xW60xH50mm



■ **NO:L-149**
禁烟牌
No smoking stand
L220xW60xH55mm



■ **NO:L-150**
亞克力臺牌座
Acrylic table number stand
L220xH100mm



■ **NO:L-151**
亞克力臺牌座
Acrylic table number stand
L220xH90mm



■ **NO:L-152**亞克力臺牌座
Acrylic table number stand
L200xW40xH110mm



■ **NO:L-153**
亞克力臺牌座
Acrylic table number stand
L80xW28xH40mm



■ **NO:L-154**
亞克力臺牌座
Acrylic table number stand
L85xW35xH60mm



■ **NO:L-155**
亞克力臺牌座
Acrylic table number stand
L60xW44xH63mm



■ **NO:L-156**
亞克力臺牌座
Acrylic table number stand
L100xW37xH55mm



■ **NO:L-157**
臺號座
Table number stand
L90xH220mm
L100xH265mm
L200xH535mm



■ **NO:L-158**
臺號座
Table number stand
L90xH190mm



■ **NO:L-159**
臺號座
Table number stand
L90xH110mm



■ **NO:L-160**
臺號座
Table number stand
L90xH85mm



■ **NO:L-161**
臺號座
Table number stand
φ 118xH160mm



■ **NO:L-162**
臺號座
Table number stand
L105xW58xH160mm



■ **NO:L-163**
臺號座
Table number stand
L90xW86xH160mm



■ **NO:L-164**
臺號座
Table number stand
L105xW58xH160mm



■ **NO:L-165**
臺號座
Table number stand
L105xW58xH160mm



■ **NO:L-166**
臺號座
Table number stand
L105xW86xH170mm



■ **NO:L-108**
雙面臺號座
Table number stand
W220xH240mm



■ **NO:185D**
旋轉臺牌座
Table number stand
L190xH185mm



■ **NO:L-167**
臺號座
Table number stand
L170xW75xH180mm



■ **NO:185E**
彈簧夾臺號座
Table number stand
H120mm



■ **NO:185G**
臺號座
Table number stand
H90mm



■ **NO:L-111**
臺號座
Table number stand
H250mm



■ **NO:L-110**
臺號座
Table number stand
H200mm



■ **NO:L-109**
臺號座
Table number stand
H150mm



■ **NO:L-107**
樹形臺號座
Table number stand
W200xH270mm



■ **NO:L-117**
臺號座
Table number stand
L85xW80xH30mm



■ **NO:L-118**
臺號座
Table number stand
L80xW70xH190mm



■ **NO:5620**
Table number stand
L120xW90xH40mm



■ **NO:L-141**
臺號座
Table number stand
φ 140xH370mm



■ **NO:L-142**
臺號座
Table number stand
φ 109xH430mm



■ **NO:L-146**
臺號座
Table number stand
H205mm



■ **NO:L-144**
臺號座
Table number stand
φ 90xH380mm



■ **NO:L-145**
臺號座
Table number stand
φ 102xH380mm
φ 102xH480mm



数字牌 (圆形) A: ϕ 80mm
 B: ϕ 100mm
 C: ϕ 120mm



■ NO:L-128
 臺號座
 Table number stand
 L78xH127mm

■ NO:L-129
 臺號座
 Table number stand
 L78xH190mm

■ NO:L-130
 臺號座
 Table number stand
 L78xH60mm

■ NO:L-131
 臺號座
 Table number stand
 L78xH630mm

■ NO:L-132
 臺號座
 Table number stand
 L78xH290mm

■ NO:L-133
 臺號座
 Table number stand
 L78xH460mm

■ NO:L-168
 臺號座
 Table number stand
 ϕ 130xH460mm

■ NO:L-169
 臺號座
 Table number stand
 ϕ 130xH530mm

■ NO:L-143
 臺號座
 Table number stand
 ϕ 120xH530mm

■ NO:L-170
 臺號座
 Table number stand
 ϕ 130xH530mm



数字牌 (方形) A: 80*80mm
 B: 100*100mm
 C: 120*120mm

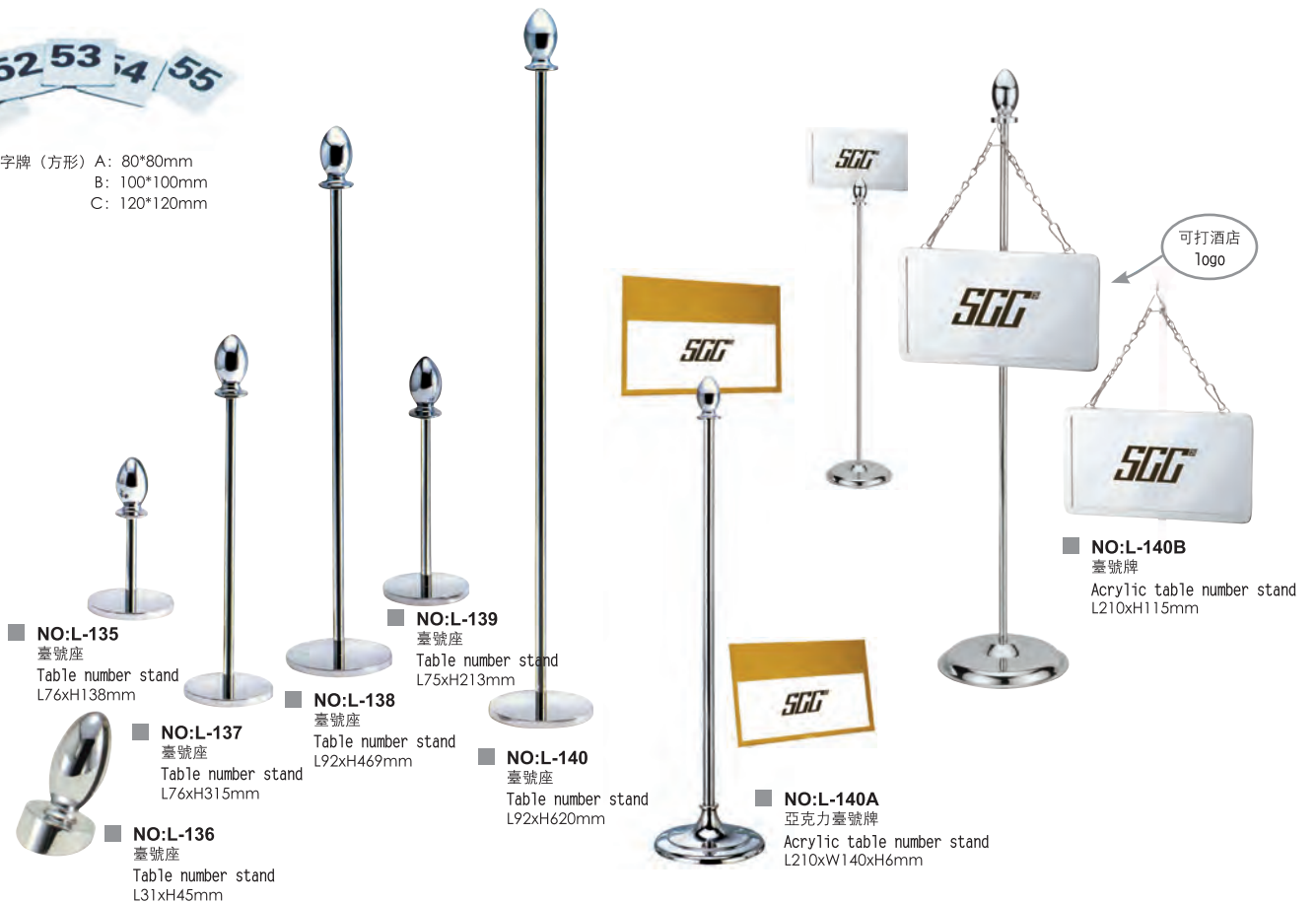

■ NO:L-135
 臺號座
 Table number stand
 L76xH138mm

■ NO:L-136
 臺號座
 Table number stand
 L31xH45mm

■ NO:L-137
 臺號座
 Table number stand
 L76xH315mm

■ NO:L-138
 臺號座
 Table number stand
 L92xH469mm

■ NO:L-139
 臺號座
 Table number stand
 L75xH213mm

■ NO:L-140
 臺號座
 Table number stand
 L92xH620mm

■ NO:L-140A
 亞克力臺號牌
 Acrylic table number stand
 L210xW140xH6mm

■ NO:L-140B
 臺號牌
 Acrylic table number stand
 L210xH115mm

可打酒店
 logo





■ NO:P-127
錐形花盆座 Vase
W250xH170mm



■ NO:P-129
錐形花盆座 Vase
W100xH110mm



■ NO:P-130
直身花瓶 Vase
H181mm



■ NO:P-131
錐形細花瓶 Vase
φ 185xH45mm



■ NO:P-132
錐形大花瓶 Vase
φ 105xH242mm
φ 280xH242mm



■ NO:P-149
蛋形大花瓶 Vase
A:L100xW45xH70mm
B:L180xW75xH150mm
C:L285xW95xH250mm



■ NO:P-150
花瓶 Vase
φ 55x φ 18xH175mm



■ NO:P-151
花瓶 Vase
φ 55x φ 18xH175mm



■ NO:P-152
花瓶 Vase
L115xW80xH290mm

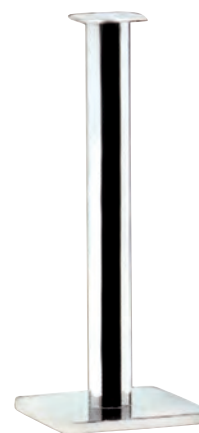

■ NO:P-119
花瓶 Vase
L82xH160mm



■ **NO:207A**
單綫圓形 Napkin ring
φ 40xW32mm



■ **NO:207B**
雙綫圓形 Napkin ring
φ 40xW30mm



■ **NO:207C**
通花 Napkin ring
φ 45xW40mm



■ **NO:207E**
間金 Napkin ring
φ 45xW25mm

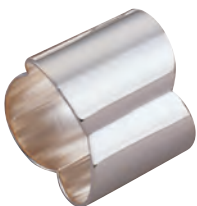

■ **NO:N-143**
三瓣梅 Napkin ring
φ 42xW35mm

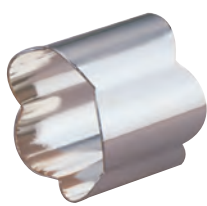

■ **NO:207G**
四瓣梅 Napkin ring
φ 44xW35mm



■ **NO:207H**
六瓣梅 Napkin ring
φ 44xW35mm

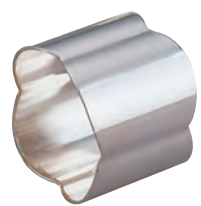

■ **NO:207I**
五瓣梅 Napkin ring
φ 44xW35mm



■ **NO:207J**
菊花 Napkin ring
φ 41xW28mm



■ **NO:207L**
棱形 Napkin ring
L50xW30mm



■ **NO:207S**
弹簧形 Napkin ring
φ 46xW33mm



■ **NO:207T**
星形 Napkin ring
φ 58xW45mm



■ **NO:207U**
锤点 Napkin ring
φ 50xW25mm



■ **NO:207V**
蟹爪形 Napkin ring
φ 60xW32mm



■ **NO:207W**
厚装鼓形(锤点)
Napkin ring
φ 40xW32mm



■ **NO:207X**
厚装鼓形 Napkin ring
φ 40xW32mm



■ **NO:207Y**
锤点双圈绕形 Napkin ring
φ 50xW25mm



■ **NO:N-131**
叶形巾圈 Napkin ring
φ 40mm

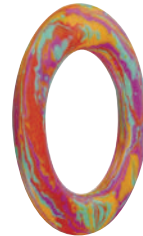

■ **NO:207Z1**
圆形巾圈 Napkin ring
内: φ 45mm
外: φ 75mm



■ **NO:207Z2**
圆形巾圈 Napkin ring
内: φ 45mm
外: φ 75mm



■ **NO:207Z3**
席巾圈 Napkin ring
L43xW35xW30mm



■ **NO:207Z4**
席巾圈 Napkin ring
φ 45xL40mm



■ **NO:207Z7**
席巾圈 Napkin ring
φ 45xL40mm



■ **NO:207Z8**
席巾圈 Napkin ring
φ 45xL40mm



■ **NO:207Z5**
席巾圈 Napkin ring
φ 55mm



■ **NO:207Z6**
席巾圈 Napkin ring
φ 55mm



■ **NO:S-106**
席巾圈 Napkin ring
φ 50mm



■ **NO:207Z9**
席巾圈 Napkin ring
φ 50mm

席巾圈系列 *Napkin ring series*



■ **NO:N-128**
旋形席巾圈 Napkin ring
φ 58xW45mm



■ **NO:207Z10**
席巾圈 Napkin ring
L70xW30xH40mm



■ **NO:207Z11**
席巾圈 Napkin ring
φ 40xW70mm



■ **NO:207Z12**
席巾圈 Napkin ring
φ 40xW70mm



■ **NO:207Z13**
席巾圈 Napkin ring
L55xW30xmm



■ **NO:N-151**
绿玛瑙席巾圈
Green agate napkin ring
φ 40xW40mm



■ **NO:182D1**
红玛瑙席巾圈
Red agate napkin ring
φ 48xW45mm



■ **NO:N-150**
黑玛瑙席巾圈
Black agate napkin ring
φ 40xW40mm



■ **NO:N-147**
绿玉石席巾圈
Green stone napkin ring
φ 40xW40mm



■ **NO:N-148**
绿彩石席巾圈
Dark-green stone napkin ring
φ 40xW40mm



■ **NO:S-216**
玻璃黑席巾圈
Black glass napkin ring
φ 48xW45mm



■ **NO:229H**
白玉石席巾圈
White stone napkin ring
φ 48xW45mm



■ **NO:207Z14**
席巾圈 Napkin ring
φ 60xW87mm



■ **NO:207Z15**
席巾圈 Napkin ring
φ 55 xW38 mm



烟灰缸系列 Ashtray series



■ NO:Q-110C
玉石烟灰盅 Ashtray
φ 200xH60mm

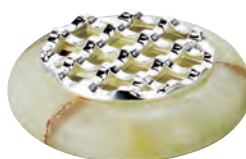

■ NO:Q-109C
玉石烟灰盅 Ashtray
φ 140xH40mm



■ NO:Q-109B
九孔烟盅 Ashtray
L70xH45mm
表面效果金, 银, 古



■ NO:Q-110A
烟盅 Ashtray
L140xH50mm
表面效果金, 银, 古



■ NO:Q-109A
九孔烟盅 Ashtray
L70xH45mm
表面效果金, 银, 古



■ NO:Q-110B
烟盅 Ashtray
L140xH50mm
表面效果金, 银, 古

烟灰缸系列 Ashtray series



■ NO:208A
圓形烟灰碟 Ashtray
φ98xH12mm



■ NO:208B
圓形烟灰碟 (深口) Ashtray
φ113xH25mm



■ NO:208C
方形烟灰碟 Ashtray
L106xW106mm



■ NO:208D
錘點方形烟灰碟 Ashtray
L106xW106mm



■ NO:208E
鼓形烟灰盅 Ashtray
φ100xH40mm



■ NO:208F
圓形烟灰盅 Ashtray
φ126xH31mm



■ NO:208G
錘點烟灰盅 Ashtray
φ126xH31mm



■ NO:208H
鼓形烟灰盅 Ashtray
φ137xH43mm



■ NO:208I
鑄造烟灰盅 Ashtray
φ83mm



■ NO:208J
三頭龍烟灰盅 Ashtray
φ118xH28mm



■ NO:208K
雪茄座 Cigar holder
φ55xH120mm



■ NO:208L
雪茄烟灰盅 Cigar ashtray
φ80xL125xH52mm



■ NO:208M
魚形烟灰盅 Ashtray
φ126xH121mm



■ NO:208 O
烟灰盅連底碟 Ashtray
3" φ96mm
4" φ132mm



■ NO:208 P
烟灰盅連底碟 Ashtray
5" φ113mm



■ NO:208 Q
烟灰盅連底碟 Ashtray
6" φ190mm



■ NO:R-101
通花杯托 Cup holder
φ 68xH125mm



■ NO:R-102
旋形杯托 Cup holder
φ 60xH125mm



■ NO:R-103
旋形錘點杯托 Cup holder
φ 60xH140mm



■ NO:R-104
杯托 Cup holder
φ 60xH96mm



■ NO:R-107
杯托 Cup holder
φ 65xH96mm



■ NO:R-109
杯托 Cup holder
φ 62xH85mm



■ NO:R-110
通花杯托 Cup holder
φ 70xH80mm



■ NO:210
啤酒杯 Beer mug
φ 97xH132mm



■ NO:203A
牙籤盒 Toothpick box
L110xW40xH22mm

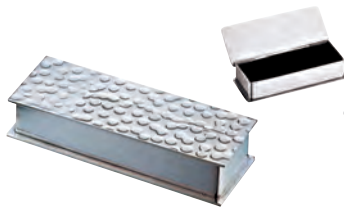

■ NO:203B
錘點牙籤盒 Toothpick box
L110xW40xH22mm



■ NO:203D
牙籤盒 Toothpick box
L100xW48xH25mm



■ NO:S-185
通花牙籤盒 Toothpick box
L110xW40xH22mm



■ NO:205C
竹節牙籤筒
Toothpick holder
φ 30xH60mm



■ NO:205D
杯形牙籤筒
Toothpick holder
φ 38xH70mm



■ NO:205E
牙籤筒
Toothpick holder
φ 32xH115mm



■ NO:205F
牙籤筒
Toothpick holder
φ 50xH100mm



■ NO:205G
牙籤筒
Toothpick holder
φ 27xH63mm



■ NO:205H
牙籤筒
Toothpick holder
φ 30xH50mm



■ NO:205I
牙籤筒
Toothpick holder
φ 25xH55mm



■ NO:205J
牙籤筒
Toothpick holder
φ 25xH61mm



NO:I-102
 鑄花邊服務盤
 Serving tray
 A:L470xW325mm
 B:L470xW370mm
 c:L580xW420mm



NO:I-104B
 圓形鑄花邊服務盤
 Serving tray
 A: ϕ 495mm
 B: ϕ 560mm



NO:I-103B
 鑄花邊服務盤
 Serving tray
 A:L580xW325mm
 B:L580xW370mm
 c:L690xW420mm



NO:I-103C
 鑄花邊服務盤
 Serving tray
 A: ϕ 600xW490mm
 B: ϕ 670xW560mm



■ **NO:I-105**
無柄橢圓形鏡臺盤
Serving tray
A:L480xW330mm
B:L565xW437mm

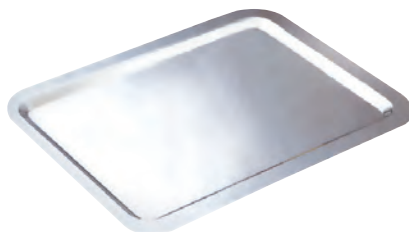

■ **NO:I-107**
無柄方形鏡臺盤
Serving tray
A:L470xW325mm
B:L470xW370mm
C:L580xW420mm



■ **NO:I-106**
無柄圓形鏡臺盤
Serving tray
A: ϕ 495mm
B: ϕ 560mm



■ **NO:I-110**
疊柄橢圓形鏡臺盤
Serving tray
A:L575xW330mm
B:L675xW437mm



■ **NO:I-111**
疊柄方形鏡臺盤
Serving tray
A:L610xW325mm
B:L610xW370mm
C:L720xW420mm



■ **NO:I-112**
疊柄圓形鏡臺盤
Serving tray
A: ϕ 620xW490mm
B: ϕ 690xW560mm



■ **NO:I-115**
帶柄圓形鏡臺盤
Serving tray
A: ϕ 605xW335mm
B: ϕ 685xW430mm

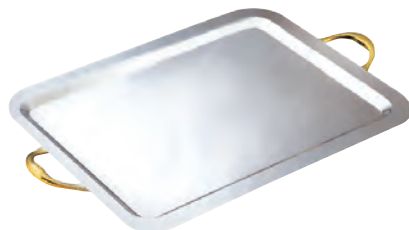

■ **NO:I-114**
帶柄方形鏡臺盤
Serving tray
A:L595xW325mm
B:L595xW370mm
C:L695xW420mm



■ **NO:I-113**
帶柄橢圓形鏡臺盤
Serving tray
A: ϕ 590xW330mm
B: ϕ 670xW437mm

服務托盤系列 *Serving tray series*



■ **NO:I-119A**
蛋形自助餐盤
Serving tray
L490xW390mm



■ **NO:I-119B**
服務盤
Serving tray
A:L575xW325mm
B:L575xW367mm
C:L690xW420mm



■ **NO:I-119C**
蛋形自助餐盤
Serving tray
L520xW330mm



■ **NO:214C1**
橢圓形自助餐盤
Serving tray
φ 520x φ 330mm



■ **NO:214D1**
橢圓形洋花邊盤
Serving tray
φ 410x φ 330mm



■ **NO:I-120**
有柄圓形鏡臺盤
Serving tray
φ 480xH20mm



■ **NO:214C**
圓形自助餐盤
Serving tray
φ 490x φ 380mm



■ **NO:214D**
洋花邊圓盤
Serving tray
φ 380mm



■ **NO:I-108**
服務盤
Serving tray
L300xW190xH41mm

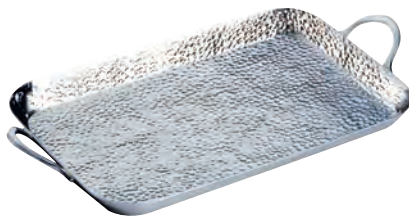

■ **NO:I-109**
服務盤
Serving tray
L300xW190mm

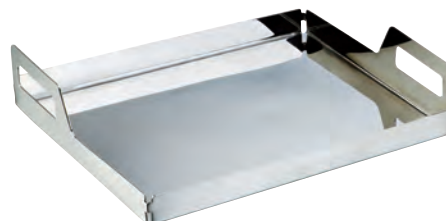

■ **NO:I-121**
方形鏡臺盤
Serving tray
L355xW290xH70mm



■ **NO:I-122A**
帶柄橢圓形鏡臺盤
Serving tray
A: ϕ 590xW330mm
B: ϕ 675xW437mm



■ **NO:I-122B**
帶柄方形鏡臺盤
Serving tray
A:L585xW325mm
B:L585xW370mm
C:L695xW420mm



■ **NO:I-122C**
帶柄圓形鏡臺盤
Serving tray
A: ϕ 605xW495mm
B: ϕ 670xW560mm



■ **NO:I-123**
長方形自助餐盤
Serving tray
L700xW420mm



■ **NO:I-101**
鑄花邊服務盤
Serving tray
A:L580xW325mm
B:L580xW370mm
C:L690xW420mm



■ **NO:214H**
方形自助餐盤
Serving tray
A:L580xW325mm
B:L580xW370mm
C:L690xW420mm



■ **NO:I-124**
服務盤
Serving tray
L505xW365mm



■ NO:O-115
不銹鋼紙巾座
Tissue stand
L130xW130xH40mm

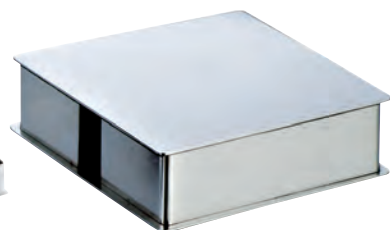

■ NO:5020G
紙巾盒 Tissue box
L130xW130xH40mm

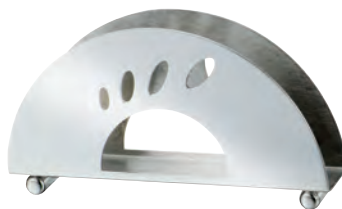

■ NO:O-116
不銹鋼紙巾座
Tissue stand
L150xW30xH79mm



■ NO:O-114
紙巾盒 Tissue box
L220xW110xH140mm



■ NO:O-117
紙巾盒 Tissue box
L120xW120xH130mm



■ **NO:O-105**
紙巾架 Tissue stand
L130xW130xH130mm



■ **NO:O-106**
紙巾架 Tissue stand
L130xW130xH130mm



■ **NO:O-102**
紙巾架 Tissue stand
L215xW215xH280mm



■ **NO:O-103**
不銹鋼紙巾座
Tissue stand
L190xW240xH185mm



■ **NO:O-101**
方形紙巾架
Tissue stand
L150xW150xH150mm



■ **NO:O-104**
不銹鋼紙巾座
Tissue stand
L150xW150xH150mm



■ **NO:O-111A**
紙巾盒 Tissue box
L120xW120xH75mm



■ **NO:O-111B**
紙巾盒 Tissue box
L110xW110xH135mm



■ **NO:O-112**
紙巾盒 Tissue box
L145xW145xH145mm



■ NO:O-118
紙巾盒 Tissue box
L165xW165xH160mm



■ NO:O-109
紙巾盒 Tissue box
L105xW130xH60mm



■ NO:O-110
紙巾盒 Tissue box
L245xW130xH85mm



■ NO:O-178
紙巾盒 Tissue box
L246xW131xH92mm

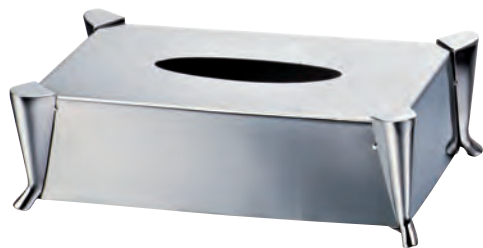

■ NO:O-113
紙巾盒 Tissue box
L220xW140xH80mm



■ NO:O-108
紙巾盒 Tissue box
L220xW110xH60mm



客房用品 - 木、鋼 / 亞克力組合系列
Room items-Black wood series



NO:5013



NO:5013A
啡茶盤 Coffee and tea tray
L370xW250xH30mm



NO:5013B
儲物盒 Amenities box
L200xW280xH130mm



NO:5013C
杯座 Glass tumbler
L200xW220xH35mm



NO:5013D
吧臺食物盤 Mini bar tray
L200xW330xH60mm



NO:5013E
垃圾桶 Trash bin
A:L240xW240xH290mm
B:L190xW190xH220mm

金屬 Metal



NO:5013F1
長方形紙巾盒 Rectangle tissue box
L240xW130xH70mm
NO:5013F2
正方形紙巾盒 Square tissue box
L135xW135xH150mm



NO:5013G
化妝瓶盤 Dispenser bottle tray
L70xW70xH20mm

金屬 Metal



NO:5013H
肥皂碟 Soap dish
L90xW90xH20mm

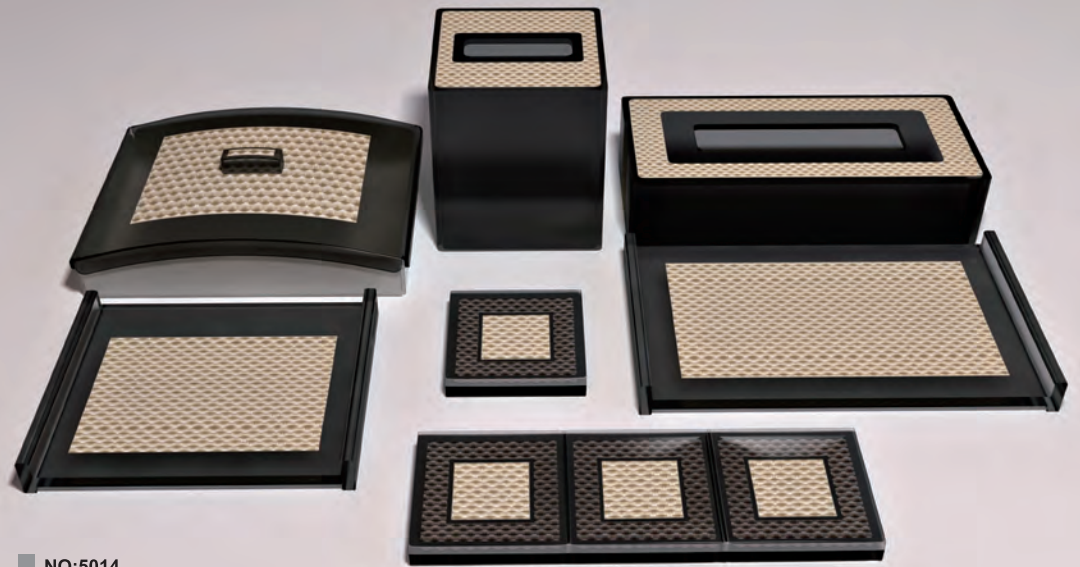

■ NO:5014



■ NO:5014A
毛巾盤 Towel tray
L230xW160xH30mm



■ NO:5014B
水杯盤 Glass tumbler & mineral water tray
L300xW160xH30mm



■ NO:5014C
長方形紙巾盒 Rectangle tissue box
L250xW135xH70mm

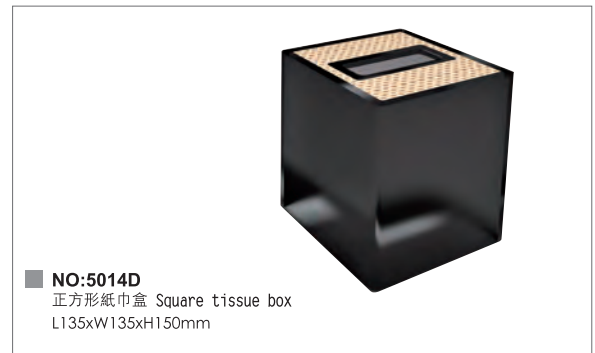

■ NO:5014D
正方形紙巾盒 Square tissue box
L135xW135xH150mm



■ NO:5014E
儲物盒 Amenities box
L280xW230xH80mm



■ NO:5014F
肥皂碟 Soap dish
L90xW90xH25mm



■ NO:5014G
化妝瓶盤 Dispenser bottle tray
L27xW90xH25mm

客房用品 - 亞克力包金邊系列
Room items-Acrylic with gold trim series



■ NO:5015

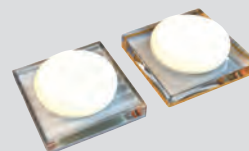

■ NO:5015J
肥皂碟 Soap dish
L80xW80xH25mm



■ NO:5015A
雜件盤 Stationary tray
L260xW80xH25mm



B1
B2
■ NO:5015B
多用途盤 Multy purpose tray
L280xW160xH50mm



■ NO:5015C
化妝瓶盤 Liquid amenities tray
L260xW80xH25mm



■ NO:5015D
長方形紙巾盒 Rectangle tissue box
L250xW135xH70mm



■ NO:5015E
正方形紙巾盒 Square tissue box
L135xW135xH150mm



■ NO:5015F
設施套裝 Amenities set
設施盒 Amenities box:L110xW240xH60mm
設施盤 Amenities box:L160xW200xH30mm
肥皂碟 Soap dish :L80xW80xH25mm
容器 Bottle dispenser:H100xD50mm



■ NO:5015G
服務盤 Minibar tray
L250xW300xH30mm



■ NO:5015H
多用途盤 Coffee & tea set
L370xW250xH30mm



■ NO:5015I
毛巾盤 Towel tray
L200xW150xH50mm



NO:5016

果绿 咖黑 橙黄 紫红 天蓝 纯白
可提供以上顏色

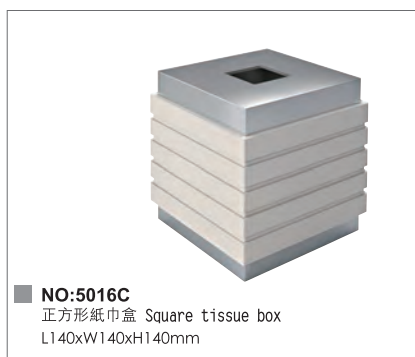



果绿 咖黑 橙黄 紫红 天蓝 纯白

可提供以上顏色

NO:5017





果绿 咖黑 橙黄 紫红 天蓝 纯白
可提供以上颜色

NO:5018



NO:5018A
啡茶盤 Coffee & tea tray
L320xW470xH30mm

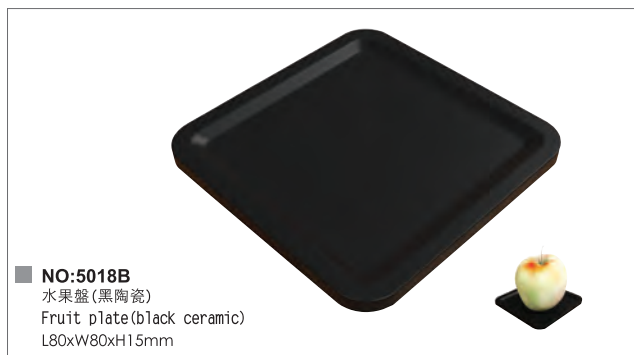

NO:5018B
水果盤(黑陶瓷)
Fruit plate(black ceramic)
L80xW80xH15mm



NO:5018C
冰桶盤 Ice bucket tray
L200xW200xH30mm

NO:5018D



NO:5018E
啡茶盤 Condiment tray
圆盘:φ 120mm
方盘:L160xH70mm



NO:5018F
水果碗(黑木) Fruit bowl(black wood)
L200xW100xH80mm



NO:5018G
迷你盤 Minibar tray
L270xW320xH30mm

G1



■ NO:5019A
服務盤 Minibar tray
L520xW340xH25mm



■ NO:5019



■ NO:5019G
礦泉水架 Bottle holder
L73 xW73xH77mm



■ NO:5019B
杯托 Cup holder
L220 xW120xH15mm



■ NO:5019C
什錦盒 Stationary box
L245xW155xH80mm

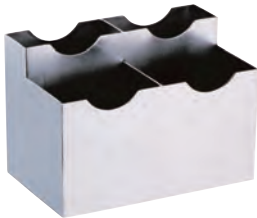

■ NO:5019D
什錦盒 Stationary box
L135xW80xH100mm



■ NO:5019E
什錦盒 Stationary box
L130xW80xH80mm

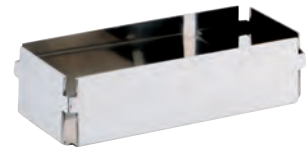

■ NO:5019F
什錦盒 Stationary box
L190xW70xH70mm



■ NO:5065
首飾/綿簽盒 Sign a box Jewelry/cotton
L95xW95xH70mm



■ NO:5066
紙巾盒 Tissue box
L145xW230xH230mm



■ NO:5067
垃圾桶 Trash barrel
L230xW230xH230mm

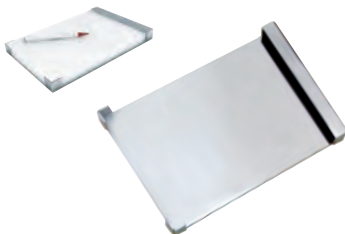

■ NO:5068A
便條托
L155xW104xH12mm

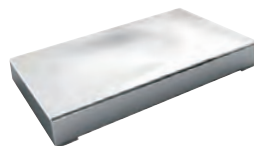

■ NO:5068B
肥皂托
L152xW88xH12mm



■ NO:5068C
浴缸托
L405xW100xH25mm



■ **NO:5020A**
盤 Tray
大L237xW220xH10mm
中L200xW100xH10mm
小L180xW80xH10mm



■ **NO:5020B**
盤 Tray
大L266xW144xH10mm
中L247xW150xH13mm
小L130xW107xH7mm



■ **NO:5020C**
盤 Tray
大L280xW90xH20mm
中L170xW85xH15mm
小L150xW82xH15mm

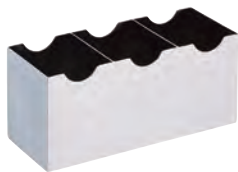

■ **NO:5020D**
糖包盒 Sugar box
L205xW80xH80mm



■ **NO:5020E**
六角形托盤 Serving tray
L455xW355xH35mm



■ **NO:5020F**
方形托盤 Serving tray
L455xW355xH35mm



■ **NO:5020G**
紙巾盒 Tissue box
L130xW130xH40mm



■ **NO:5020H**
香皂碟 Soap dish
L110xW104xH50mm



■ **NO:5020I**
香皂碟 Soap dish
L110xW85xH10mm



■ **NO:5020J**
香皂碟 Soap dish
L105xW130xH15mm



■ NO:5021B
服務盤 Minibar tray
L400xW110mm



■ NO:5021A
服務盤 Minibar tray
L400xW110mm



■ NO:5021C
服務盤 Minibar tray
L220xW330mm



■ NO:5021D
服務盤 Minibar tray
L220xW330mm



■ NO:5021E
服務盤 Minibar tray
L220xW330mm



■ NO:5021F
服務盤 Minibar tray
L220xW330mm



■ NO:5021G
服務盤 Minibar tray
L500xW200mm

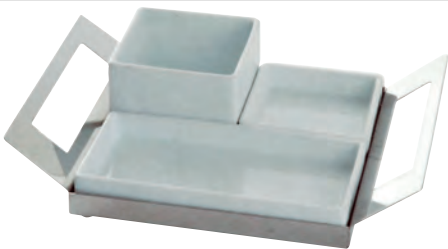

■ NO:5021H
服務盤/客房什錦套盤
Minibar tray
L310xW550mm



■ NO:5021I
服務盤/客房什錦套盤
Minibar tray
L380xW80xH55mm



■ NO:5021J
服務盤/客房什錦套盤
Minibar tray
L300xW250xH55mm



■ NO:5021K
服務盤/客房什錦套盤
Minibar tray
L230xW160xH55mm



■ NO:5022A
冰桶 Ice bucket
φ 140xH190mm



■ NO:5022B
冰桶 Ice bucket
φ 130xH200mm
夹: 140mm



■ NO:5022C
冰桶 Ice bucket
L120xW120xH170mm



■ NO:5022D
冰桶 Ice bucket
L110xW110xH190mm



■ NO:M-175
方型浴品架 Cake cage
L500xW290xH370mm



■ NO:M-176B
鳥籠款浴品架 Cake cage
φ 280xH520mm





NO:5024
第五元素



NO:5025
極美社



NO:5026
蘭韵



NO:5027
佰物源



NO:5028
幸運芳絲



NO:5029
俏顏秋語



NO:5030
梵摩詩



NO:5031
魅麗



NO:5032
源物語



NO:5033
綠雅



NO:5034
香草之心

客房電器系列 *Room appliance series*



■ NO:5035
電熱水煲 Electric kettle



■ NO:5036
電熱水煲 Electric Kettle



■ NO:5037
電熱水煲 Electric kettle



■ NO:5038
電熱水煲 Electric Kettle



■ NO:5038
電吹風 Electric hairdier



■ NO:5039
電吹風 Electric hairdier



■ NO:5040
電吹風 Electric hairdier



■ NO:5043
電筒 Electric torch



■ NO:5045
防毒面具 Safety mask



■ NO:5058
圓錐形毛巾筐 Valet basket
φ 410xH425mm



■ NO:5059
圓形毛巾筐 Valet basket
φ 350xH385mm



■ NO:5060
錐形毛巾筐 Valet basket
L420xW350xH350mm



■ NO:5061
脚踏垃圾桶 Room dustbin
φ 205xH285mm
φ 240xH335mm



■ NO:5062
脚踏垃圾桶 Room dustbin
φ 205xH285mm
φ 240xH335mm



■ NO:5063
帶蓋垃圾桶 Room dustbin
φ 250xH300mm



■ NO:5064
橢圓雙層垃圾桶 Room dustbin
L260xW190xH270mm
L220xW158xH220mm



■ NO:5041
帶夾衣架 Hanger



■ NO:5042
衣架 Hanger



■ NO:5044
燙衣板 Ironing board



■ NO:5046
煲
φ 160xW80mm



■ NO:5048
煲
φ 180xW90mm



■ NO:5050
煲
φ 1200xW110mm



■ NO:5047
煲
φ 240xW130mm



■ NO:5049
煲
φ 160xW80mm



■ NO:5051
煲
φ 240xW65mm



■ NO:5052
煲
φ 160xW80mm



■ NO:5054
煲
φ 180xW90mm



■ NO:5056
煲
φ 200xW110mm



■ NO:5053
煲
φ 240xW130mm



■ NO:5055
煲
φ 160xW80mm



■ NO:5057
煲
φ 240xW65mm



Website: <http://scc168.b2b.hc.360.com> <http://fsshunchuang.en.alibaba.com>

佛山順創酒店制品有限公司
FOSHAN SHUNCHUANG HOTEL ARTICLES CO.,LTD

香 港 順 誠
H O N G K O N G S H U N C H E N G

特约省份一级经销:

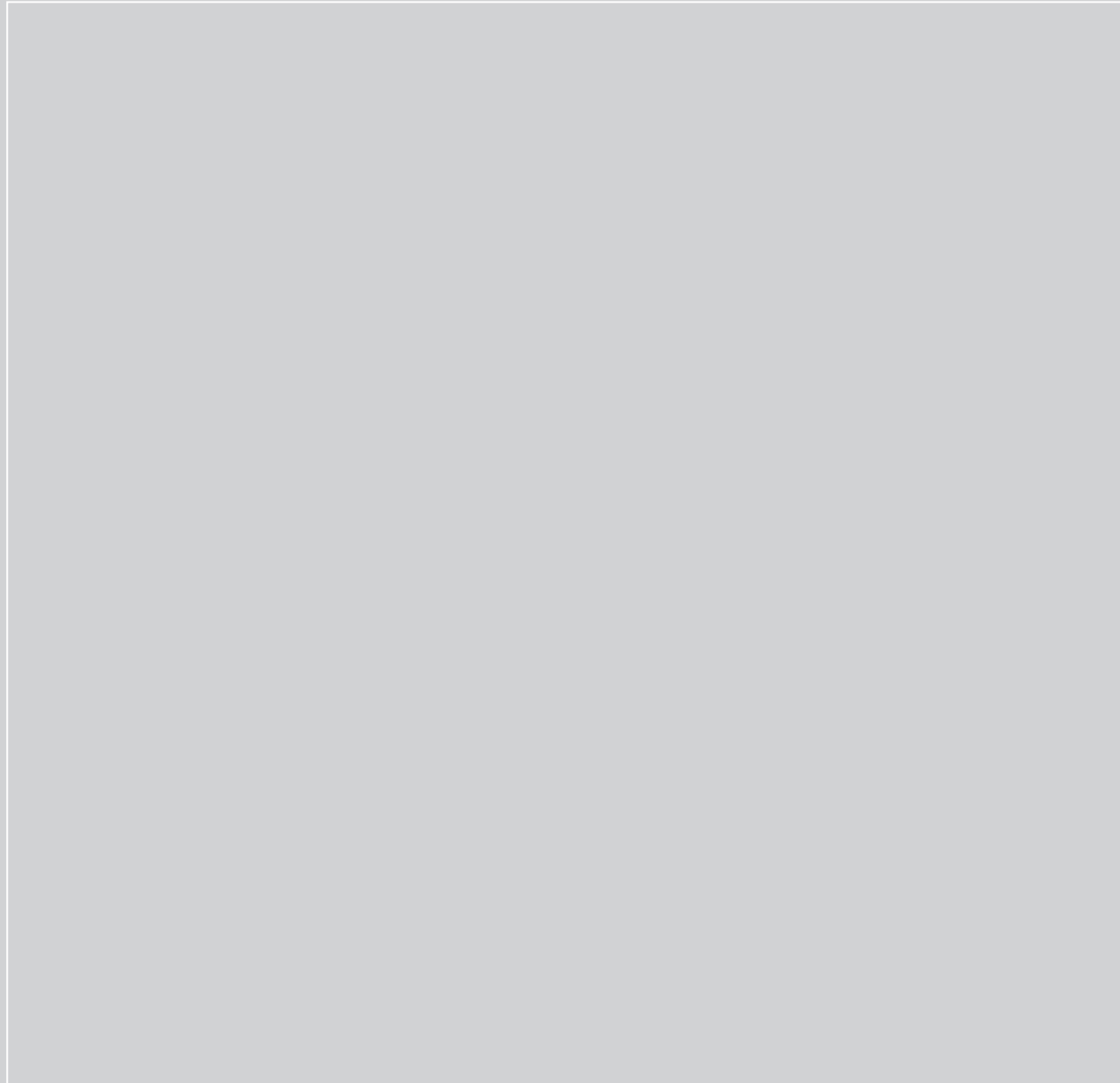

/ 创
新
突
破
/
追
求
完
美
/
挚
诚
经
营
/
品
味
生
活
/
/



 SGC[®]







佛山順創
FOSHAN SHUNCHUANG
香港順誠
HONG KONG SHUNCHENG

本廠創建於1965年并在香港開始制作金銀器餐具產品，由傳統的純手工打制發展為集現代電子機械設備、激光科技設備于一身的現代化企業。嚴謹的表面電鍍工藝處理成就每一件金銀器餐具，高品質的產品享譽酒店管理公司及海內外中東皇室貴族認可。

順創·SGG[®] 研制的自助餐產品可提供無數可能的創意去展示食物的吸引力和高度可靈活搭配，創造檔次與無限空間。在研發過程中，SGG[®] 非常注重自助餐產品的兼容性，每個產品的線條，外觀兼具創意與構思。

SGG[®] 秉承創新精神，將傳統和創意相結合，將盡最大的努力把“華麗”和“光亮”帶到餐桌與藝術主題的自助餐空間裏。更使SGG[®] 的品牌成為行業之最。

Our company founded in 1965 in Hongkong, from the manual manufacture of the technicians of the old generation in the beginning to fully mechanized plunger to day, from processing of manufactured body in the beginning to the productive enterprise entity in integrating manufaction, production, surface-electroplating processing, development & research and marketing into itself, manufacturing professionally the gold and silver tableware and buffetwane.specialized in making silver wares and stainless steel buffetwares.

SGG[®] SHUNCHUAN offers innumerable possibilities to present food optially appealing and highly flexible, provides level and freedom.When developing mew products ,it is of high importance for SGG[®] to considerate the compatibility among the individual systems. All products consist of creativities and concepts .

Tradition and creativity combined ,it gives us creativity and flexibility .We will continue to make all efforts to bring "gorgeous" and "shiny" to the dining tables and "art buffet ".



长期合作伙伴
Reference





中餐镀金镀银桌面系列: 秉承“品质才是硬道理”的理念, *SCC* 始终坚持独立生产, 严格把关每一道工序。胚身原料选用铜或不锈钢 304, 表面电镀处理, 镀金镀银选用西德金盐、银盐及瑞士纯银条, 镀银厚度可达到 3-20 微米。致力于开发适合中西式国宴的高档金银器餐具, 并将中国特色的餐饮文化发扬光大。

Chinese Gold/Silver Plated Tableware Series: We insist the concept of Quality is top priority. Each process from the raw material to finished products is completed by ourselves independently. The raw material is copper or stainless steel 304(18/10), surface can be gold/silver plated. The silvering are selected from the sodium gold chlorohydrate and silver salt of West Germany, the thickness can reach 3 to 20 micron. We try our best to produce the deluxe golden and silver tableware, and carry forward Chinese catering culture.

自助餐主题摆件系列: 随性但彰显着个性、环境融合创意、美观却不乏视觉的冲击。这就是 *SCC* 自助餐主题元素的精髓所在。纯手工制作让产品更富有无尽的活力, 厚实的材料质感让你感受到自身的尊贵, 而你不经意的摆设, 却可能换来不一样的主题风格, 让你在惊讶中更富有满足感, 这也是 *SCC* 产品一直的追求。

Buffet Theme Decoration Series: Specific, creativity, the sense of artistic, that are what this series manifest. Manual production brings products endless vitality. Material texture makes you feel dignity. Different ways of decoration can change to other theme styles. Making your life diversified, that is the pursuit of *SCC*.



西餐桌面系列: 凭借严谨的工艺、精湛的技术和一流的创意, *SCC* 将简约、时尚、浪漫、高贵的特质发挥得淋漓尽致。产品经过冲压、烧焊、外表采用反复数次的镜面抛光、打磨等几十道严格工艺工作, 为消费者提供最佳的使用效果, *SCC* 产品是享受美食的最佳伴侣, 充分体现美食配美器的理念。

Western Style Tableware Series : With strict technology and first-class creative, exquisite technology, *SCC* describes the characteristic of simple, fashionable, romantic and noble fully. We provide perfect products for customers after stamping, welding, mirror polishing, grinding and other dozens of strict process. *SCC* is the best partners to enjoy food. Our concept is "delicious food must be with wonderful tableware".



中东皇家摆台系列: 为中东皇室度身定制的镀金镀银系列产品, 产品特性彰显中东地区特色文化, 电镀 24K 金包裹着的外观沿袭了中东的大气奢华之风, 在婚礼、宴会上广受欢迎, 深得各经销商及酒店的青睐。

Aristocratic Table Decoration Series with characteristic Middle East manner. The Gold plated and silver plated series, customized for royals, manifests distinct culture of the Middle East. 24k gold plated surface Inherits luxurious, also exquisite style. Their popularity in weddings and banquets wins the deep favor of dealers and hotels.

礼品家饰系列: 品质决定价值, 而 SGG 礼品系列工艺的精细雕琢, 融合国际一流的设计大师理念, 产品的金银电镀厚度达到 3-20 微米不等, 使产品价值提升到一定的层次, 让产品实用性和收藏性融合升华。SGG 礼品是送礼、收藏的首选!

Gift Decoration Series. Value lies in Quality. SCC gifts enjoy excelsior craft, especially the integration of first class international design concept. Moreover, The gold or silver electroplating thickness reaches a range of 3 μ m to 20 μ m. SCC are first choice for gift giving and collecting.



镀金



镀银



Room Items Wood Series

客房沐浴用品系列: 我们将 SGG 客房用品的原木材经过严谨的手工制作, 结合优质的 304 不锈钢, 设计了一系列的实用、时尚和高贵的客房用品, 还有来自巴黎风格的一次性客房用品系列, 不仅让您忘却出差、旅游的疲惫, 而且仿如置身于充满香薰沐浴的大自然当中, 令人心旷神怡。



Room and bath Amenities: The logs of SGG room amenities is deal with environmental paint, with the superior stainless stell 304, we designed many series of practical fashion and noble room amenities. And the Paris style disposable goods not only make you forget the exhaustion from the business trip and travel, but also relax and happy into the nature filled with aromatherapy. gift giving and collecting.



目 录 CONTENTS

温馨提示

金银器产品护理，切勿用带酸性或碱性的清洁剂擦洗，只需用温水加中性优质洗洁精清洗，再用清水洗干净。因产品不断更新改良，如本目录产品与实物尺寸有出入时，敬请以实物为准。



筷子架 Chopsticks stand
P010~014



筷子 Chopsticks
P015~017



席面更 Table spoon
P018~019



公壳 / 公壳座 Soup ladle / stand
P020~021



服务长更叉
Serving spoon & fork
P022~022



毛巾碟 Towel tray
P023~025



洗手盅 Finger bowl
P026~027



翅碗 Shark fin soup bowl
P028~028



球形翅盅
Superior shark fin stand
P029~031



暖茶座 Teapot warmer
P032~033



席面碟 Show plate
P034~036



味碟 Sauce dipper
P037~037



蒸笼架 Dim sun basket
P038~039



火锅煲 Hot pot set
P040~042



圆形器皿碟盖 Circular utensils
P043~044



汤锅 Large soup bowl
P045~046



冬瓜盅
White gour soup set
P047~047



服务器皿 Serving items
P048~049



酒类器皿 Drinkware
P050~051



龙凤镀金系列
Gold plated series
P052~053



龙凤满汉花金系列
Gold and silver plated series
P054~059



圆珠款系列
Round ball
P060~061



皇朝款系列
Dynasty series
P062~063



皇冠款系列
Crown series
P064~065



通花款系列
Hollow out series
P066~067



挽手款系列
Ring series
P068~070



玉石系列
Jade plate series
P071~082



餐垫系列
Placemat series
P083~083



配搭参考图片





■ NO:111A1
橋形筷子架
L60mm



■ NO:111A3
龍頭筷子架
L53mm



■ NO:111A5
橢圓筷子架
L58mm



■ NO:111B1
長條四綫筷子架
L70mm



■ NO:111B2
羅馬筷子架
L80mm



■ NO:111B3
枕頭筷子架
L55mm



■ NO:111B4
長條單綫筷子架
L48mm



■ NO:111B5
H形筷子架
L39mm



■ NO:111C3
帝皇筷子架
L82mm



■ NO:111D1
六角形筷子架
L75mm



■ NO:111D2
蛋形筷子架
L79mm



■ NO:111D3
磚形筷子架
L73mm



■ NO:111D4
加侖筷子架
L78mm



■ NO:111D5
波板筷子架
L84mm



■ NO:111E1
皇朝珠腳筷子架
L75mm



■ NO:111E2
皇朝筷子架
L75mm



■ NO:111E3
皇朝珠腳筷子架
L75mm



■ NO:111E4
皇朝筷子架
L75mm



■ NO:111E5
鯨魚筷子架
L90mm



■ NO:111F1
神燈筷子架
L70mm



■ NO:111F2
光身神燈筷子架
L70mm



■ NO:111F3
蓮花筷子架
L100mm



■ NO:111F4
光身筷子架
L100mm



■ NO:111F5
蓮花筷子架
L85mm



■ NO:111G1
筷子架
L95mm



■ NO:111G3
浪珠筷子架
L92mm



■ NO:111G4
浪珠梅花筷子架
L95mm



■ NO:111H2
雙用筷子架
L102mm



■ NO:111I2
龍形筷子架
L92mm



■ NO:111J1
如意筷子架
L99mm



■ NO:111J2
天鵝筷子架
L120mm



■ NO:111J3
圓座筷子架
L80mm



■ NO:111J4
羅馬筷子架
L90mm



■ NO:111J5
條形筷子架
L88mm



■ NO:111J6
合形筷子架
L90mm

筷子架系列 Chopsticks stand series



■ NO:111J7
龍頭筷子架
L88mm



■ NO:111J8
浪形筷子架
L81mm



■ NO:111J9
錘印筷子架
L80mm



■ NO:111K1
杆形筷子架
L75mm



■ NO:111K2
帆船筷子架
L50mm



■ NO:111K3
六角形筷子架
L92mm



■ NO:111K4
圓珠筷子架
L95mm



■ NO:111K5
工形筷子架
L84mm



■ NO:111K6
雙用筷子架
L81mm



■ NO:111K7
單用筷子架
L55mm



■ NO:111K8
三用錘點筷子架
L82mm

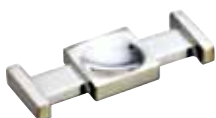

■ NO:111K9
工形筷子架
L84mm



■ NO:111L1
三用筷子架
L122mm



■ NO:111L2
雙用筷子架
L90mm



■ NO:S-106
筷子架
φ40mm



■ NO:S-115
單用筷子架
L60mm



■ NO:S-116B
小鴿壽筷子架
L90xH40mm



■ NO:S-117
彎形筷子架
L80mm



■ NO:S-118
壓格紋筷子架
L82mm



■ NO:S-119
雙用筷子架
L82mm



■ NO:S-120
雙用筷子架
L80mm



■ NO:S-121
雙用筷子架
L90mm



■ NO:S-123
拱形筷子架
L80mm



■ NO:S-125
三用筷子架
L120mm



■ NO:S-126
三角形筷子架
L80mm



■ NO:S-127
錘紋筷子架
L80mm



■ NO:S-128
單用筷子架
L40mm



■ NO:S-129
單用筷子架
L40mm



■ NO:S-130
單用筷子架
L40mm



■ NO:S-131
單用筷子架
L50mm



■ NO:S-136
合形筷子架
L75mm



■ NO:S-137
錘點浪形筷子架
L100mm



■ NO:S-138
壓格紋筷子架
L68mm



■ NO:S-145
單用筷子架
L85mm



■ NO:S-109
小獅子形筷子架
L100mm

配搭参考图片







■ NO:112A1
明珠筷子(密胶)
L246mm



■ NO:112A2
梅蘭菊竹筷子(密胶)
L266mm



■ NO:112A3
明珠龍鳳筷子(密胶)
L253mm



■ NO:112A4
龍鳳筷子(密胶)
L266mm



■ NO:112A5
人字形筷子(密胶)
L269mm



■ NO:112B1
羅馬筷子(密胶)
L266mm



■ NO:112B2
三綫筷子(紅木)
L270mm



■ NO:112B3
龍鳳筷子(紅木)
L273mm



■ NO:112B4
三綫筷子(密胶)
L266mm



■ NO:112B5
明珠光身筷子(紅木)
L261mm



■ NO:112C1
梅蘭菊竹筷子(紅木)
L273mm



■ NO:112C4
花金筷子(密胶)
L266mm



■ NO:112C5
雙綫筷子(密胶)
L263mm



■ NO:112D1
短珠筷子(密胶)
L255mm



■ NO:112D2
錘點筷子(密胶)
L263mm



■ NO:112E1
長珠筷子(密胶)
L254mm



■ NO:112E2
明珠筷子(密胶)
L248mm



■ NO:112E3
短雙綫筷子(密胶)
L252mm



■ NO:112E5
彩石筷子(密胶)
L250mm



■ NO:182A4
圓珠紅瑪瑙
L270mm



■ NO:182A5
圓珠黑瑪瑙
L270mm



■ NO:182A6
圓珠綠瑪瑙
L270mm



■ NO:112F4
玉石筷子
L270mm



筷子系列 Chopsticks series



■ NO:112H1
光身筷子
L270mm



■ NO:112H2
光身筷子
L270mm



■ NO:112H3
斜口光身筷子
L270mm



■ NO:112H4
斜口光身筷子
L268mm



■ NO:112H5
圓頭筷子
L243mm



■ NO:112H6
格紋筷子
L273mm



■ NO:112H9
斜口光身筷子
L268mm



■ NO:112M1
圓珠筷子
L252mm



■ NO:112M5
長頭筷子
L268mm



■ NO:112M6
短頭筷子
L268mm



■ NO:112M7
葉子長頭筷子
L250mm



■ NO:112M8
葉子頭筷子
L250mm



■ NO:112M9
網形密胺筷子
L268mm



■ NO:112N1
竹節密胺筷子
L268mm



■ NO:112N2
菱形密胺筷子
L268mm

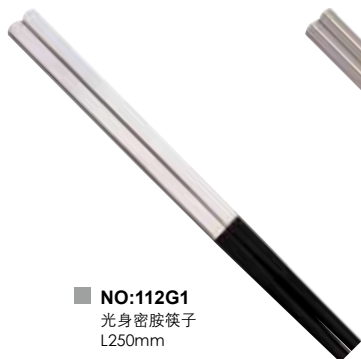

■ NO:112G1
光身密胺筷子
L250mm

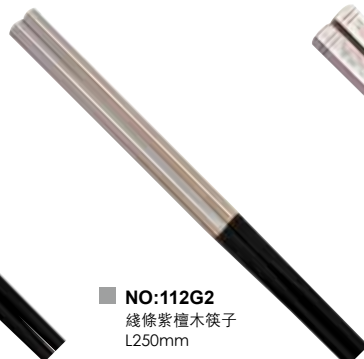

■ NO:112G2
縫條紫檀木筷子
L250mm

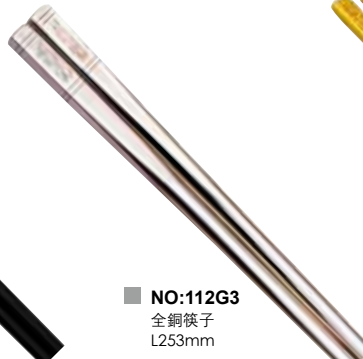

■ NO:112G3
全銅筷子
L253mm



■ NO:112G4
全銅花筷子
L225mm





■ NO:113A
彩石直身席面更
L200mm



■ NO:113B
皇朝席面更
L205mm



■ NO:113C
羅馬光身席面更
L194mm



■ NO:113D
扇柄席面更
L203mm



■ NO:113D1
扇柄席面更
L200mm



■ NO:113E
龍形席面更
L205mm



■ NO:113F
三寶席面更
L200mm



■ NO:113I
帝皇席面更
L212mm



■ NO:113J
魚形席面更
L206mm



■ NO:113K
羅馬席面更
L194mm



■ NO:113L
皇朝光身席面更
L205mm



■ NO:113M
溫莎席面更
L184mm



■ NO:113N
直身光身席面更
L200mm



■ NO:113O
彎形光身席面更
L192mm



■ NO:113S
錘點席面更
L218mm



■ NO:113T
光身席面更
L199mm



■ NO:113U
棱角席面更
L200mm



■ NO:113V
圓珠席面更
L200mm



■ NO:113W
斜角席面更
L200mm



■ NO:116F
錘點茶更
L155mm



■ NO:S-151
格紋席面更
L205mm



■ NO:S-154
錘點席面更
L194mm



■ NO:114A
龍形公殼座
L133mm



■ NO:114C
皇朝珠腳公殼座
L100mm



■ NO:114F
三寶公殼座
L160mm



■ NO:114M
圓珠公殼座
L160mm



■ NO:114L
蓮花公殼座
L147mm



■ NO:114I
磚形公殼座
L100mm



■ NO:S-116A
大鴨壽公殼座
L130xH60mm



■ NO:S-142
獅子公殼座
L110mm



■ NO:115A
龍形大公殼
L382mm

■ NO:115B
龍形細公殼
L274mm



■ NO:115D
皇朝大公殼
L370mm

■ NO:115E
皇朝細公殼
L272mm



■ NO:115F
明珠大公殼
L395mm

■ NO:115G
明珠細公殼
L253mm



■ NO:115H
三寶大公殼
L385mm

■ NO:115I
三寶細公殼
L259mm



■ NO:115L
錘點大公殼
L395mm

■ NO:115M
錘點細公殼
L253mm



■ NO:115N
圓珠大公殼
L395mm

■ NO:115S
圓珠細公殼
L253mm



■ NO:S-178
壓格紋大公殼
L395mm

■ NO:S-178A
壓格紋細公殼
L253mm



■ NO:115C
龍形湯篩(大)
L382mm



服務長更叉系列 *Sering spoon & fork series*



■ NO:116A1
龍形長更
L230mm

■ NO:116A2
龍形長叉
L228mm



■ NO:116B1
皇朝長更
L226mm

■ NO:116B2
皇朝長叉
L226mm



■ NO:116C1
三寶長更
L228mm

■ NO:116C2
三寶長叉
L223mm



■ NO:116D1
明珠長更
L228mm

■ NO:116D2
明珠長叉
L225mm



■ NO:116E1
龍柄餐刀
L199mm

■ NO:116E2
龍柄餐叉
L199mm



■ NO:116G
不銹鋼汁更
L192mm

■ NO:116H
不銹鋼汁更
L220mm



■ NO:S-177A
壓格紋服務更
L233mm

■ NO:S-177B
壓格紋服務叉
L230mm



■ NO:D-190
汁更座
L110xH60mm



■ **NO:117A**
光身毛巾碟
3x5 L132xW95mm
4x5 L126xW100mm
4x6 L155xW104mm



■ **NO:117B1** 烧珠邊毛巾碟(龍鳳)
3x5 L130xW95mm
4x5 L125xW100mm
4x6 L148xW103mm

■ **NO:117B2** 壓珠邊毛巾碟(龍鳳)
3x5 L135xW99mm
4x5 L132xW104mm
4x6 L155xW108mm



■ **NO:117C1** 燒加侖邊毛巾碟
3x5 L130xW95mm
4x5 L125xW100mm
4x6 L148xW103mm)

■ **NO:117C2** 壓加侖邊毛巾碟
3x5 L132xW99mm
4x5 L132xW103mm
4x6 L155xW108mm



■ **NO:117D**
海棠毛巾碟
L125xW95mm



■ **NO:117E**
毛巾碟
L130xW84mm



■ **NO:117F**
蛋形毛巾碟
L144xW108mm



■ **NO:117G**
船形毛巾碟
L212xW130mm



■ **NO:117H**
條形加命邊毛巾碟
L193xW83mm



■ **NO:117I**
條形光身毛巾碟
L193xW83mm



■ **NO:117J**
條形珠邊毛巾碟
L193xW83mm



■ **NO:117L**
錘點毛巾碟
L157xW64mm



■ **NO:117M**
錘點毛巾碟
L115xW64mm



■ **NO:117N**
錘點毛巾碟
(大)L130xW65mm
(小)L110xW62mm



■ **NO:117P**
光身毛巾碟
L157xW64mm



■ **NO:117Q**
光身毛巾碟
L115xW64mm



■ **NO:117R**
光身毛巾碟
(大)L130xW65mm
(小)L110xW62mm



■ **NO:117S**
錘點毛巾碟
3x5 L132xW95mm
4x5 L126xW100mm
4x6 L155xW104mm



■ **NO:117T**
錘點毛巾碟
3x5 L132xW95mm
4x5 L126xW100mm
4x6 L155xW104mm



■ **NO:117K**
雲龍毛巾盒
L223xW141xH121mm



■ **NO:117U1**
船形毛巾碟
L153xW73xH11mm



■ **NO:117U2**
船形毛巾碟
L153xW73xH11mm



■ **NO:117V**
毛巾碟
L160xW80xH18mm



■ **NO:117W**
挽手毛巾碟
L125xW98xH35mm



■ **NO:117X**
挽手毛巾碟
L149xW128xH33mm



■ **NO:S-182**
通花毛巾碟
L150xW125xH10mm



■ **NO:S-183**
通花毛巾碟
L157xW64xH30mm



■ **NO:J-119**
毛巾碟
L180xW60xH30mm



■ **NO:J-120**
毛巾碟
L160xW80mm



■ **NO:117O**
錘點毛巾碟
L241xW119mm



■ NO:168F
洗手盆
φ 115mm

■ NO:168F1
洗手盆底碟
φ 140mm



■ NO:168G
洗手盆
φ 115mm

■ NO:168G1
洗手盆底碟
φ 152mm



■ NO:168H
洗手盆
φ 110mm

■ NO:168H1
洗手盆底碟
φ 152mm



■ NO:S-186A
洗手盆
φ 117mm

■ NO:S-186B
洗手盆底碟
φ 140mm



■ NO:168A
瓣形洗手盅
φ 125xH50mm



■ NO:168A1
瓣形洗手盅底碟
φ 158mm



■ NO:168B
碗形洗手盅
φ 117xH44mm



■ NO:168B1
碗形洗手盅底碟
φ 140mm



■ NO:168C
綫條洗手盅
φ 110xH45mm



■ NO:168C1
綫條洗手盅底碟
φ 140mm



■ NO:168D
錘點洗手盅
φ 115xH44mm



■ NO:168D1
錘點洗手盅底碟
φ 140mm



■ NO:168E
滿漢洗手盅
φ 124xH70mm



■ NO:168E1
滿漢洗手盅底碟
φ 158mm



■ NO:118A
龍耳翅碗
φ 103xH60mm



■ NO:118F
三寶翅碗
φ 103xH60mm



■ NO:118G
魚形翅碗
φ 103xH60mm



■ NO:118H
珠耳翅碗
φ 103xH60mm



■ NO:118I
皇朝翅碗
φ 103xH60mm



■ NO:118P
圓形挽手翅碗
φ 103xH60mm



■ NO:118J
滿漢龍耳翅碗
φ 103xH64mm



■ NO:118D
翅碗底碟
φ 167xH33mm



■ NO:118K
滿漢龍耳帶蓋翅碗
φ 113xH121mm



■ NO:118E
翅碗底碟
φ 155xH33mm



■ NO:119A
球形翅盅(龍鳳)
φ 132xH130mm



■ NO:119B
球形翅盅(皇朝)
φ 132xH130mm



■ NO:119C
球形翅盅(三寶)
φ 132xH130mm



■ NO:119E
滿漢鮑翅盅連底碟(每位用)
φ 125xH134xL210mm
φ 183xH30mm(底碟)





■ NO:119D
球形翅盅(明珠)
φ 132xH130mm



■ NO:119F
蓋式球形翅盅
φ 132xH160mm



■ NO:119I
錘點球形翅盅/底碟
φ 103xH64mm/ φ 217mm



■ NO:119J
光身球形翅盅連底碟
盅 φ 132xH160mm
碟 φ 217mm(底碟)



■ NO:S-193
通花球形翅盅連底碟
盅 φ 132xH130mm
碟 φ 217mm(底碟)



■ NO:119H
球形翅盅底碟(綫條)
φ 195mm



■ NO:119G
球形翅盅底碟(龍鳳)
φ 217mm



■ NO:120C



■ NO:120E
每位魚翅碗連匙
玻璃 φ104x50mm



■ NO:120A

編號 Code	暖湯座 (英寸) Soup warmer	外 φ (mm)	內 φ (mm)	H (mm)	暖湯座底碟 Soup warmer tray	
					(英寸)	φ (mm)
120A ₁	4-1/2"	115	98	95	7"	183
120A ₂	5"	126	111	92	7-1/2"	194
120A ₃	6"	152	132	93	8-1/2"	215
120A ₄	7"	175	156	92	9"	255
120A ₅	8"	204	194	90	10"	311



■ NO:120B

編號 Code	暖湯座 (英寸) Soup warmer	外 φ (mm)	內 φ (mm)	H (mm)	暖湯座底碟 Soup warmer tray	
					(英寸)	φ (mm)
120B ₁	4-1/2"	115	98	95	7"	183
120B ₂	5"	126	111	92	7-1/2"	194
120B ₃	6"	152	132	93	9"	232
120B ₄	7"	175	156	92	10"	255
120B ₅	8"	204	194	90	12"	311

編號 Code	暖湯座 (英寸) Soup warmer	外 φ (mm)	內 φ (mm)	H (mm)	暖湯座底碟 Soup warmer tray	
					(英寸)	φ (mm)
120C ₁	5"	124	108	92	7.5"	194

NO:160

蟹具壹套

Crab tool set

- A蟹墊板L130xW100mm
- B1大蟹形座L200xW165mm
- B2小蟹形座L160xW160mm
- C蟹針L200mm
- C1蟹針L205mm
- D蟹錘L160mm
- E蟹鉗(方柄)L163mm
- F蟹鉗(圓柄)L172mm
- G蟹剪L185mm
- H蟹剪L170mm

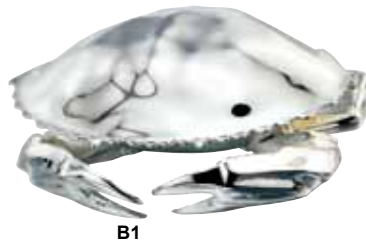

B1



B2



H



E



F

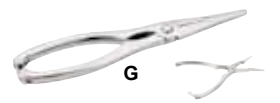

G

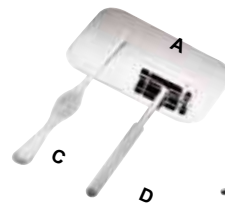

A



C



D

C1





■ NO:123
飯碗蓋
Rice bowl cover
φ 116xH55mm



■ NO:S-197
通花炖盅
座 φ 110x H128mm



■ NO:S-198
炖盅底碟
碟 φ 190mm



■ NO:N-126A
蛋架連碟
总体 φ 138xH105mm
架 L47x H102mm



■ NO:125
南瓜盅
Pumpkin stand
φ 122x H105mm/底碟 φ 65mm



■ NO:127
木瓜盅 (每位用)
Papaya soup stand
L160xW130x H56(mm)



■ NO:N-126B
蛋架連碟
φ 50xW70mm



■ NO:124A
暖茶座
Teapot warmer
φ 52xH56mm



■ NO:124B
茶壺咀
Spout (teapot)



■ NO:126A
暖茶座
Teapot warmer
φ 150x H80mm



■ NO:S-199
通花暖茶座/暖茶座連底碟
座 φ 156x H45mm
碟 φ 230mm



■ NO:N-126B
暖茶壺連座
壺 φ 115x H240(mm)
座 φ 180x H80(mm)





NO:121A
壓珠邊席面碟
6^{1/2}" (外 ϕ 156x內 ϕ 115)mm
7" (外 ϕ 180x內 ϕ 140)mm
7^{1/2}" (外 ϕ 192x內 ϕ 140)mm
8" (外 ϕ 205x內 ϕ 150)mm
8^{1/2}" (外 ϕ 220x內 ϕ 150)mm
10" (外 ϕ 255x內 ϕ 190)mm
12" (外 ϕ 300x內 ϕ 260)mm



NO:121B
龍鳳壓珠邊席面碟
6^{1/2}" (外 ϕ 156x內 ϕ 115)mm
7" (外 ϕ 180x內 ϕ 140)mm
7^{1/2}" (外 ϕ 192x內 ϕ 140)mm
8" (外 ϕ 205x內 ϕ 150)mm
8^{1/2}" (外 ϕ 220x內 ϕ 150)mm
10" (外 ϕ 255x內 ϕ 190)mm
12" (外 ϕ 300x內 ϕ 260)mm



NO:121C
錘點壓珠邊席面碟
6^{1/2}" (外 ϕ 156x內 ϕ 115)mm
7" (外 ϕ 180x內 ϕ 140)mm
7^{1/2}" (外 ϕ 192x內 ϕ 140)mm
8" (外 ϕ 205x內 ϕ 150)mm
8^{1/2}" (外 ϕ 220x內 ϕ 150)mm
10" (外 ϕ 255x內 ϕ 190)mm
12" (外 ϕ 300x內 ϕ 260)mm



NO:121D
加侖邊席面碟
6" (外 ϕ 148x內 ϕ 115)mm
6^{1/2}" (外 ϕ 165x內 ϕ 115)mm
7" (外 ϕ 180x內 ϕ 140)mm
7^{1/2}" (外 ϕ 190x內 ϕ 140)mm
8" (外 ϕ 203x內 ϕ 150)mm
8^{1/2}" (外 ϕ 220x內 ϕ 150)mm
10" (外 ϕ 255x內 ϕ 190)mm
12" (外 ϕ 300x內 ϕ 260)mm



NO:121E
龍鳳加侖邊席面碟
6" (外 ϕ 148x內 ϕ 115)mm
6^{1/2}" (外 ϕ 165x內 ϕ 115)mm
7" (外 ϕ 180x內 ϕ 140)mm
7^{1/2}" (外 ϕ 190x內 ϕ 140)mm
8" (外 ϕ 203x內 ϕ 150)mm
8^{1/2}" (外 ϕ 220x內 ϕ 150)mm
10" (外 ϕ 255x內 ϕ 190)mm
12" (外 ϕ 300x內 ϕ 260)mm



NO:121F
錘點席面碟
6" (外 ϕ 148x內 ϕ 115)mm
6^{1/2}" (外 ϕ 165x內 ϕ 115)mm
7" (外 ϕ 180x內 ϕ 140)mm
7^{1/2}" (外 ϕ 190x內 ϕ 140)mm
8" (外 ϕ 203x內 ϕ 150)mm
8^{1/2}" (外 ϕ 220x內 ϕ 150)mm
10" (外 ϕ 255x內 ϕ 190)mm
12" (外 ϕ 300x內 ϕ 260)mm



NO:121G
光身燒珠邊席面碟
9" (外 ϕ 230x內 ϕ 175)mm
10" (外 ϕ 255x內 ϕ 190)mm
12" (外 ϕ 300x內 ϕ 260)mm



NO:121H
光身綫條席面碟
6" 6^{1/2}"
7" 7^{1/2}"
8" 8^{1/2}"
9" 10" 12"



NO:121I
光身洋花席面碟
6" 6^{1/2}"
7" 7^{1/2}"
8" 8^{1/2}"
9" 10" 12"

席面碟系列 Show plate series



■ NO:121J
錘點八角席面碟
外 ϕ 200x內 ϕ 160mm



■ NO:121R
光身八角席面碟
外 ϕ 200x內 ϕ 160mm



■ NO:121S
萬紋邊席面碟
外 ϕ 200x內 ϕ 160mm



■ NO:121M
加侖邊席面碟
9" (外 ϕ 230x內 ϕ 182)mm
11" (外 ϕ 282x內 ϕ 230)mm



■ NO:121N
光身洋花席面碟
6" 6^{1/2}"
7" 7^{1/2}"
8" 8^{1/2}"
9" 10" 12"



■ NO:121O
蛋形席面碟
L275xW183mm



■ NO:121P
震珠邊席面碟
7-1/2" (外 ϕ 195x內 ϕ 165)mm



■ NO:121K
錘點席面碟
外 ϕ 260x內 ϕ 230mm



■ NO:121L
錘點席面碟
大 ϕ 330mm
中 ϕ 255mm
小 ϕ 160mm



■ NO:121Q
三腳壓珠邊席面碟
6" 6^{1/2}"
7" 7^{1/2}"
8" 8^{1/2}"
9" 10" 12"



■ **NO:122A**
圓形三脚味碟
φ 125xH27mm



■ **NO:122B**
圓形高莊味碟
φ 125xH73mm



■ **NO:122C**
方形四脚味碟
φ 113xH56mm



■ **NO:122D**
方形高莊味碟
φ 113xH84mm



■ **NO:S-181**
通花味碟
L115xH25(mm)



■ **NO:122G**
圓形味碟(光身)
φ 120xH25mm



■ **NO:122H**
圓形高莊味碟(光身)
φ 126xH65mm



■ **NO:112K**
光身方形味碟
L113xH55mm



■ **NO:122I**
錘點圓形三脚味碟
φ 126xH25mm



■ **NO:122J**
錘點圓形高莊味碟
φ 125xH65mm



■ **NO:112L**
圓珠脚味碟
L125xH20mm



■ **NO:122E**
圓形三脚味碟(綫條)
φ 126xH25(mm)



■ **NO:122F**
圓形高莊味碟(綫條)
φ 126xH65(mm)



底部可透氣

■ NO:128

點心籠

A1:蒸籠: ϕ 90xH64mm 蓋子: ϕ 92xH10mm
 A2:蒸籠: ϕ 158xH70mm 蓋子: ϕ 160xH10mm
 A3:蒸籠: ϕ 180xH74mm 蓋子: ϕ 182xH10mm
 A4:蒸籠: ϕ 269xH79mm 蓋子: ϕ 271xH10mm
 A5:蒸籠: ϕ 345xH95mm 蓋子: ϕ 247xH10mm

■ NO:128C

疊放款點心籠

A1:蒸籠: ϕ 90xH64mm 蓋子: ϕ 92xH10mm
 A2:蒸籠: ϕ 158xH70mm 蓋子: ϕ 160xH10mm
 A3:蒸籠: ϕ 180xH74mm 蓋子: ϕ 182xH10mm
 A4:蒸籠: ϕ 269xH79mm 蓋子: ϕ 271xH10mm
 A5:蒸籠: ϕ 345xH95mm 蓋子: ϕ 247xH10mm





■ NO:128B

不帶蓋式點心籠(易取式)
 A1: ϕ 90xH60mm
 A2: ϕ 158xH60mm
 A3: ϕ 180xH60mm
 A4: ϕ 194xH60mm
 A5: ϕ 273xH60mm
 A6: ϕ 345xH60mm



■ NO:128D

方形通花點心籠

A1: 蒸籠: L90xW90xH70mm 蓋子: L93xW93xH25mm
 A2: 蒸籠: L158xW158xH70mm 蓋子: L161xW161xH25mm
 A3: 蒸籠: L180xW180xH70mm 蓋子: L183xW183xH25mm
 A4: 蒸籠: L269xW269xH70mm 蓋子: L272xW272xH25mm
 A5: 蒸籠: L345xW345xH70mm 蓋子: L348xW348xH25mm



■ NO:128E

方形點心籠

A1: 蒸籠: L90xW90xH70mm 蓋子: L93xW93xH25mm
 A2: 蒸籠: L158xW158xH70mm 蓋子: L161xW161xH25mm
 A3: 蒸籠: L180xW180xH70mm 蓋子: L183xW183xH25mm
 A4: 蒸籠: L269xW269xH70mm 蓋子: L272xW272xH25mm
 A5: 蒸籠: L345xW345xH70mm 蓋子: L348xW348xH25mm







四大特點



可透熱氣
更適用烹飪醉蝦窩

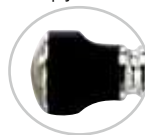

防燙處理



■ NO:129F1
通花火鍋煲(封閉式)
L245x φ 170x H270mm



■ NO:129F2
通花火鍋煲(開口式)
L245x φ 170x H270mm



精鑄工藝



通風透氣燃燒均勻



■ NO:129G1
獅子頭火鍋煲(封閉式)
L245x φ 170x H270mm



■ NO:129G2
獅子頭火鍋煲(開口式)
L245x φ 170x H270mm



■ NO:129C
日式火窩煲
φ153x H155mm



■ NO:129D
火鍋煲 (配0'底碟)
L227x φ195x H220mm
底碟 φ225mm



■ NO:129E
每位火鍋煲 (不含碟)
L210x φ160x H190mm





■ NO:130
圓形三腳碟座



■ NO:A130
錘點圓形三腳碟座

圓形三腳碟座			
編號	Round platter	φ (mm)	H (mm)
130A	8"	205/165	40
130B	9"	238/185	50
130C	10-1/2"	270/215	60
130D	11-1/2"	290/240	60
130E	13"	330/265	60
130F	15"	400/320	85
130G	17"	430/360	85
130H	18"	465/360	85
130I	20"	510/410	85



■ NO:131
圓形碟托



■ NO:B131
錘點圓形碟托

圓形碟托			
編號	Round holder	φ (mm)	H (mm)
131A	7x8"	200/222	65
131B	9x10"	230/250	75
131C	10x12"	260/285	80
131D	12x14"	285/314	85
131E	14x16"	355/385	95



■ NO:132
圓形碟托連爐架



■ NO:C132
錘點圓形碟托連爐架

圓形碟托連爐架			
編號	Round holder	φ (mm)	H (mm)
132A	7	200	65
132B	9	230	75
132C	10	260	80
132D	12	285	85
132E	14	355	95



■ NO:133
龍鳳圓蓋



■ NO:D133
錘點圓蓋

圓形餐蓋			
編號	Round cover	φ (mm)	H (mm)
130A	6-1/2"	165	55
130B	7-1/2"	190	60
130C	8-1/2"	205	65
130D	9-1/2"	245	75
130E	10-1/2"	270	85
130F	11-1/2"	295	95
130G	13"	335	100
130H	15"	385	105
130I	17"	435	105

蛋形器皿系列 *Oval utensil series*



■ **NO:134**
蛋形碟座
Oval cover



■ **NO:A134**
錘點蛋形碟座

蛋形碟座				
編號	Oval platter	L (mm)	W (mm)	H (mm)
134A	9"	230/180	180	40
134B	11"	280/210	222	45
134C	13"	330/250	245	45
134D	15"	390/310	310	65
134E	17"	435/360	340	70
134F	20"	510/420	390	75
134G	22"	560/470	440	85



■ **NO:135**
蛋形碟托



■ **NO:B135**
錘點蛋形碟托

蛋形碟托				
編號	Oval holder	L (mm)	W (mm)	H (mm)
135A	7x8"	167/190	130/150	60
135B	9x10"	195/210	145/165	70
135C	10x12"	245/260	160/180	75
135D	12x14"	275/305	185/220	75
135E	14x16"	345/360	225/250	85
135F	16x18"	380/395	255/265	90



■ **NO:136**
蛋形碟托連爐架
Oval plate holder w/warmer1



■ **NO:C136**
錘點蛋形碟托連爐架

蛋形碟托連爐架				
編號	Oval holder	L (mm)	W (mm)	H (mm)
136A	7"	167	130	60
136B	9"	195	145	60
136C	10"	245	160	75
136D	12"	275	185	75
136E	14"	345	225	85
136F	16"	380	255	90



■ **NO:137**
蛋形龍鳳蓋
Oval cover



■ **NO:D137**
錘點蛋形蓋

蛋形龍鳳蓋				
編號	Oval cover	L (mm)	W (mm)	H (mm)
137A	8"	200	150	55
137B	9"	210	160	55
137C	10"	250	180	70
137D	12"	300	215	80
137E	14"	330	240	80
137F	16"	400	300	90
137G	18"	450	310	90
137H	20"	510	390	120



NO:138
 A₁:8-10位龍耳翅窩 Shark fin tureen for 8-10 persons
 L400x φ 265xH100mm
 A₂:10-12位龍耳翅窩
 L475x φ 300xH125mm



NO:139
 A₁:8-10位挽手腰身翅窩
 Shark fin tureen set
 L365x φ 270xH100mm
 A₂:10-12位挽手腰身翅窩
 L400x φ 305xH105mm



NO:140
 醉蝦窩 Drunken shrimp casserole
 A: φ 275xL330xH60(mm)
 B: φ 305xL362xH65(mm)



NO:141
 三寶鐘點翅窩
 A₁:8-10: L400x φ 2665xH100mm
 A₂:10-12: L475x φ 300xH125mm



湯鍋器皿系列 *Large soup bowl series*



■ **NO:129A**
響螺碟莊連蓋
L225xW170xH140mm



■ **NO:151**
每位鮑魚碟連蓋
Abalone plate with cover
蓋: ϕ 223/ ϕ 170mm
蓋: ϕ 165mm



■ **NO:144**
蛇窩暖座連架 Snake soup set
身A: ϕ 275xH62mm
B: ϕ 320xH70mm
架A: ϕ 245x165mm
B: ϕ 290x165mm



■ **NO:147**
沙窩煲 Casserole stand
4#L210xW175mm 5#L290xW230mm
6#L300xW260mm 7#L330xW270mm



■ **NO:146**
鮑魚窩莊 Abalone dish stand
11" ϕ 270xH73mm
12" ϕ 300xH75mm
13" ϕ 332xH75mm



■ NO:145A
龍鳳冬瓜盅 White gourd soup set
A: ϕ 216xH335mm
B: ϕ 250xH370mm



■ NO:145C
光身冬瓜盅 White gourd soup set
A: ϕ 216xH315mm
B: ϕ 255xH330mm



■ NO:148A
四脚猪形碟莊
Suckling pig platter w/4 legs
L560x345xH90mm



■ NO:148B
錘點四脚猪形碟莊
Suckling pig platter w/4 legs
L560x345xH90mm



■ NO:148C
四脚猪形光身碟莊
Suckling pig platter w/4 legs
L560x345xH90mm



■ **NO:149B**
錘點果盤/四格玻璃轉盤
φ 460xH80mm



■ **NO:150**
潮州轉盤
Revolving teochew dish holder
15" φ 400xH80mm
17" φ 460xH80mm
四格玻璃 300mm



■ **NO:152A**
毛巾籃連夾
Towel basket w/tong
大:L320xW240xH90mm A₁L200mm
細:L240xW157xH68mm A₂L130mm



■ **NO:153**
龍柄分魚刀叉連盤
Fish knife&fork w/tray
A:L370xW233xH78mm
B:龍柄分魚刀L282mm
C:龍柄分魚叉L298mm



■ **NO:152B**
毛巾籃連夾
Towel basket w/tong
L320xW240xH90mm B₁L250mm



■ **NO:152C**
錘點毛巾籃連夾
L320xW240xH90mm C₁L200mm



■ **NO:O-107**
服務盤
L260xW260xH195mm





■ **NO:156**
山瑞莊
Turtle stand
L500xW350xH130mm



■ **NO:158**
A1: 四頭龍柱轉莊 L650xH430mm
A2: 兩頭龍柱轉莊 L650xH430mm
2Arms/4arms revolving dish stand (dragon)



■ **NO:159**
A1: 四頭花柱轉莊 L669xH430mm
A2: 兩頭花柱轉莊 L669xH430mm
2Arms/4arms revolving dish stand (dragon)



■ **NO:157**
刺身船
Dragon boat
L730xW210xH315mm



■ **NO:161**
A1大鳳咀花雕酒壺
H253mm ML930
B1花雕酒杯
H75mm



■ **NO:161**
A1細鳳咀花雕酒壺
H201mm ML500
B1白酒杯
H65mm



■ **NO:162B**
大鳳咀花雕酒壺座
L242xW152xH75mm



■ **NO:162A**
細鳳咀花雕酒壺座
L182xW134xH71mm



■ **NO:163A**
滿漢大鳳咀花雕酒壺
H253mm ML930



■ **NO:163B**
滿漢細鳳咀花雕酒壺
H201mm ML500



■ **NO:164A**
大滿漢酒壺座(細)
L182xW134xH71mm



■ **NO:164B**
滿漢酒壺座(大)
L242xW152xH75mm



■ **NO:164C**
大滿漢深莊酒壺座(細)
L198xW136xH120mm



■ **NO:167A**
龍耳冰桶
φ 150xH132mm
冰夾:L200mm



■ **NO:167B**
大滿漢龍耳冰桶
φ 128xH144mm



■ **NO:165A**
龍耳香檳酒桶
Wine cooler
φ 220xH220mm



■ **NO:165B**
大滿漢香檳酒桶
φ 210xH225mm

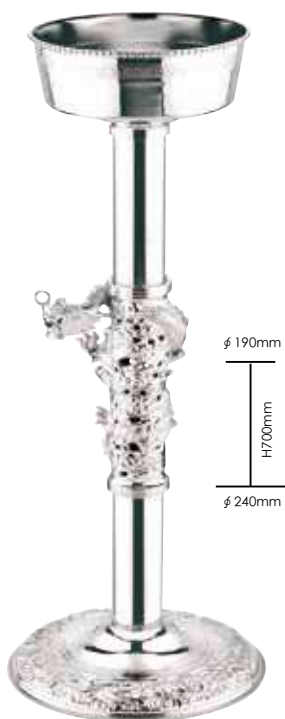

■ **NO:166A**
龍柱香檳酒架



■ **NO:166B**
大滿漢龍柱香檳酒架





以上產品尺寸參考銀器系列





■ NO:119E
大滿漢圓形三脚碟座
大: ϕ 590x ϕ 412mm
小: ϕ 462x ϕ 320mm



■ NO:151
大滿漢圓形鮑魚碟連蓋
碟: ϕ 223/ ϕ 170mm
蓋: ϕ 165mm



■ NO:171
圓形龍鳳蓋
17": ϕ 435mm
13": ϕ 335mm



■ NO:170
大滿漢圓形三脚碟座
大: 外 ϕ 590x ϕ 412mm
小: 外 ϕ 462x ϕ 320mm



■ NO:173
蛋形龍鳳蓋
20": L510mm
18": L450mm



■ NO:172
大滿漢蛋形碟座
大: 外L622x內L470xW500mm
小: 外L584x內L420xW474mm



■ NO:152A
毛巾藍連夾 Towel basket with tong
大: L320xW240xH90mm
細: L240xW157xH68mm



■ NO:174
龍蝦盤
L840xW440mm



■ **NO:143**
 冬瓜盅 White gourd soup set
 A: ϕ 216xH335mm
 B: ϕ 255xH370mm



■ **NO:169**
 A: 大滿漢四脚猪形碟莊
 B: 四脚猪形碟莊
 L560xW345xH90mm



■ **NO:164C**
 大滿漢深莊酒壺座(細)
 L198xW136xH120mm



■ **NO:163A**
 滿漢大鳳咀花雕酒壺
 H253mm ML930



■ **NO:163B**
 滿漢細鳳咀花雕酒壺
 H201mm ML500



■ **NO:138**
 A1: 8-10位龍耳翅窩 Shark fin tureen for 8-10 person
 L400x ϕ 265xH100mm
 A2: 10-12位龍耳翅窩
 L475x ϕ 300xH125mm



■ **NO:139**
 A1: 8-10位挽手腰身翅窩
 Shark fin tureen set
 L365x ϕ 270xH100mm
 A2: 10-12位挽手腰身翅窩
 L400x ϕ 305xH105mm



■ NO:167B
大滿漢龍耳冰桶
φ 128xH144mm



■ NO:165B
大滿漢香檳酒桶
φ 210xH225mm



■ NO:166A
龍柱香檳酒架



■ NO:157
壽司船
Dragon boat
L730xW210xH315mm







■ NO:111K4
圓珠筷子架
L95mm

■ NO:114M
圓珠公殼座
L160mm

■ NO:113V
圓珠席面更
L200mm

■ NO:115S
圓珠細公殼
L253mm

■ NO:115N
圓珠大公殼
L395mm



■ NO:112D1
短珠筷子(密股)
L255mm



■ NO:117R
光身毛巾碟
大L130xW65mm
小L110xW62mm



■ NO:112L
圓珠腳味碟
L125xH20mm



■ NO:119D
球形翅盅
φ132xH130mm



■ **NO:E137**
 蛋形圓珠蓋
 Oval cover
 8' 9' 10' 12' 14' 16' 18' 20'



■ **NO:E134**
 蛋形碟座
 9' 11' 13' 15' 17' 20' 22'



■ **NO:E133**
 圓形圓珠蓋
 Round cover
 6-1/2' 7-1/2' 8-1/2' 9-1/2'
 10-1/2' 11-1/2' 13' 15' 17'



■ **NO:E130**
 圓形碟座
 8' 9' 10.5' 11.5' 13' 15' 17' 18' 20'



■ **NO:141B**
 A1: 8-10位圓珠翅窩 Shark fin tureen for 8-10 person
 L400x ϕ 265xH100mm
 A2: 10-12位圓珠翅窩
 L475x ϕ 300xH125mm



■ **NO:189G**
 明珠香檳酒桶
 Champagne bucket
 ϕ 220xH220mm



■ **NO:189H**
 明珠冰桶
 Ice bucket
 ϕ 145xH132mm



■ **NO:145C**
 冬瓜盅 White gourd soup set
 A: ϕ 216xH315mm
 B: ϕ 255xH330mm



■ **NO:148C**
 四脚豬形光身碟莊
 Suckling pig platter w/4 legs
 L560x345xH90mm



■ NO:111D4
加侖筷子架
L78mm

■ NO:111E2
皇朝珠脚筷子架
L75mm

■ NO:114C
皇朝珠脚公般座
L100mm

■ NO:113D1
扇柄席面更
L200mm

■ NO:115E
皇朝細公般
L272mm

■ NO:115D
皇朝大公般
L370mm



■ NO:116B1
皇朝長更
L226mm

■ NO:116B2
皇朝長叉
L226mm

■ NO:117V
毛巾碟
L160xW80xH18mm



■ NO:112N1
竹節密胺筷子
L268mm



■ NO:119B
球形翅盅
φ132xH130mm



■ NO:168C
綫條洗手盅
φ110xH45mm



■ NO:118I
皇朝翅碗
φ103xH60mm



■ **NO:189C**
皇朝香槟酒桶
Champagne bucket
φ 220xH220mm



■ **NO:189D**
皇朝冰桶
Ice bucket
φ 145xH132mm



■ **NO:F133**
圆形皇朝盖
Round cover
6-1/2' 7-1/2' 8-1/2' 9-1/2'
10-1/2' 11-1/2' 13' 15' 17'



■ **NO:E130**
圆形碟座
8' 9' 10.5' 11.5' 13' 15' 17' 18' 20'



■ **NO:F137**
蛋形皇朝盖
Oval cover
8' 9' 10' 12' 14' 16' 18' 20'



■ **NO:E134**
蛋形碟座
9' 11' 13' 15' 17' 20' 22'



■ **NO:141C**
A₁:8-10位皇朝翅窝 Shark fin tureen for 8-10 person
L400x φ 265xH100mm
A₂:10-12位皇朝翅窝
L475x φ 300xH125mm



■ **NO:145D**
冬瓜盅 White gourd soup set
A: φ 216xH315mm
B: φ 255xH330mm



■ NO:111G1
筷子架
L95mm

■ NO:114F
三寶公般座
L160mm

■ NO:113F
三寶席面更
L200mm

■ NO:115I
三寶細公般
L259mm

■ NO:115H
三寶大公般
L385mm



■ NO:112N2
棱形密胶筷子
L268mm



■ NO:122G
圓形味碟(光身)
φ 120xH25mm



■ NO:117C1
燒加侖邊毛巾碟
3x5 L130xW95mm
4x5 L125xW100mm
4x6 L148xW103mm

■ NO:117C2
壓加侖邊毛巾碟
3x5 L132xW99mm
4x5 L132xW103mm
4x6 L155xW108mm



■ NO:168B
綫條洗手盅
盅 φ 110xH45mm
碟 φ 140mm



■ **NO:119B**
球形光身翅盅
φ 132xH130mm



■ **NO:118F**
三寶翅碗
φ 103xH60mm



■ **NO:187E**
香檳酒桶
Champagne bucket
φ 220xH220mm



■ **NO:187F**
香檳冰桶
Ice bucket
φ 145xH132mm



■ **NO:145E**
冬瓜盅 White gourd soup set
A: φ 216xH315mm
B: φ 255xH330mm



■ **NO:G133**
圓形皇冠蓋
Round cover
6-1/2' 7-1/2' 8-1/2' 9-1/2'
10-1/2' 11-1/2' 13' 15' 17'



■ **NO:F130**
圓形碟座
8' 9' 10.5' 11.5' 13' 15' 17' 18' 20'



■ **NO:G137**
蛋形皇冠蓋
Oval cover
8' 9' 10' 12' 14' 16' 18' 20'



■ **NO:F134**
蛋形碟座
9' 11' 13' 15' 17' 20' 22'



■ NO:S-118
壓格紋筷子架
L82mm



■ NO:S-138
壓格紋筷子架
L68mm



■ NO:S-185
通花牙籤盒
L110xW40xH22mm



■ NO:112H6
格紋筷子
L273mm



■ NO:S-151
格紋席面更
L205mm



■ NO:S-177A
壓格紋服務更
L233mm



■ NO:S-177B
壓格紋服務叉
L230mm



■ NO:S-178B
壓格紋大公殼
L395mm



■ NO:S-178A
壓格紋細公殼
L253mm



■ NO:S-193
通花球形翅盅連底碟
盅 ϕ 132xH130mm
碟 ϕ 217mm(底碟)



■ NO:S-186
洗手盅連碟
盅 ϕ 117mm
碟 ϕ 140mm



■ NO:S-182
通花毛巾碟
L150xW125xH10mm



■ NO:R-101
通花杯托
 ϕ 68xH125mm



■ **NO:S-194**
通花圓形碟
φ 355
φ 460



■ **NO:S-187**
通花圓形碟
φ 200
φ 225
φ 305



■ **NO:128C**
帶蓋點心籠
A: φ 92xH95mm
B: φ 168xH95mm
C: φ 176xH95mm
D: φ 192xH95mm
E: φ 273xH95mm



■ **NO:S-191**
通花蛋形碟托
7x8' 9x10' 10x12'
12x14' 14x16' 16x18'



■ **NO:E131**
通花圓形碟托
7x8' 9x10' 10x12'
12x14' 14x16'



■ **NO:S-197**
通花暖茶盅/暖茶座連底碟
座 φ 110x H128mm
碟 φ 190mm



■ **NO:H137**
蛋形通花蓋連座
蓋L310xW220x H100mm
座L420xW320x H95mm



■ **NO:H133**
圓形通花蓋連座
蓋 φ 315x H165mm
座L450x H110mm



■ **NO:S-199**
通花暖茶座/暖茶座連底碟
座 φ 156x H45mm
碟 φ 230mm



■ **NO:141D**
通花瓠窩
座L410xW310xH120mm
蓋 φ 280xH140mm



■ **NO:S-195B**
通花餐蓋連碟
蓋: 8' 10' 12'
碟: φ 305/ φ 350/ φ 460



■ **NO:145F**
冬瓜盅 White gourd soup set
φ 255xH330mm



■ NO:S-106
筷子架/席巾圈
φ 50mm



■ NO:207Z6
席巾圈
φ 55mm



■ NO:207Z5
席巾圈
φ 55mm



■ NO:111L2
雙環筷子架
L90mm



■ NO:111L1
三環筷子架
L122mm



■ NO:L-147
臺號座
φ 40mm



■ NO:P-133
單頭燭臺
H280mm



■ **NO:113W**
斜角席面更
L200mm



■ **NO:203C**
牙籤盒
L105xW40xH45mm



■ **NO:112H9**
斜口光身筷子
L268mm



■ **NO:117Y**
條形光身毛巾碟
L193xW83mm



■ **NO:117W**
挽手毛巾碟
L125xW98xH35mm



■ **NO:117X**
挽手毛巾碟
L149xW128xH33mm



■ **NO:119J**
光身球形翅盅連底碟
盅 ϕ 132xH160mm
碟 ϕ 217mm(底碟)



■ **NO:118N1**
圓形挽手翅碗
 ϕ 103xH60mm



■ **NO:118H**
洗手盅連碟
盅 ϕ 110mm
碟 ϕ 152mm



■ **NO:201F**
果仁盒
W200xH120mm



■ **NO:201G**
果仁盒
W190xH190mm



■ **NO:K-157**
 ϕ 100xH230mm

挽手款系列 *Handle series*



■ NO:1111
光身圓形碟座
φ 350mm



■ NO:1112
錘點圓形碟座
φ 360mm



■ NO:1871
圓頂蓋
Oval cover
φ 265xH160mm



■ NO:141E
圓頂翅窩 Shark fin tureen for 8-10 person
托L420xW310xH125mm
蓋L275xH125mm







■ NO:180A
圓形席面盤
φ 235xH30mm

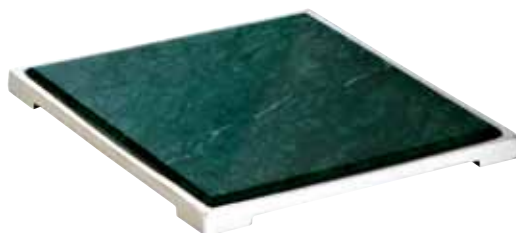

■ NO:180B
方形席面盤 (大)
L245xH25mm



■ NO:180D
經典套裝—彩石盤
L330xW210xH20mm



■ NO:180E
扇形席面盤
L320xH185mm



■ NO:180N
席巾圈
φ 48xW45mm



■ NO:180F
牙簽盒
L110xW50xH28mm



■ NO:180O
毛巾托
L140xW100xH15mm



■ NO:180G
牙簽筒
φ 52xH58mm



■ NO:180H
更托
φ 708mm



■ NO:180L
彎形席面更
L192mm



■ NO:180K
直身席面更
L200mm



■ NO:180Q
主刀
L225mm



■ NO:180P
主叉
L200mm



■ NO:180I
筷子
L270mm



■ NO:180J
一字筷子架
L60mm



■ NO:180M
彎尾筷子架
L90mm



■ NO:181A
圓形席面盤
φ 235xH30mm

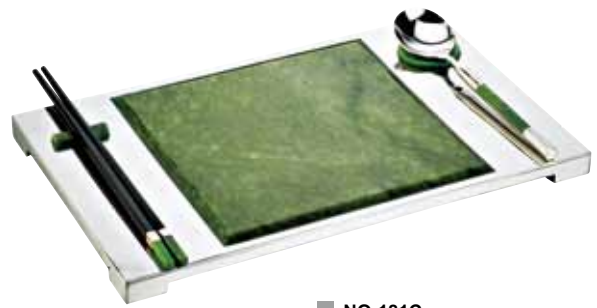

■ NO:181C
經典套裝—玉石盤
L330xW210xH20mm

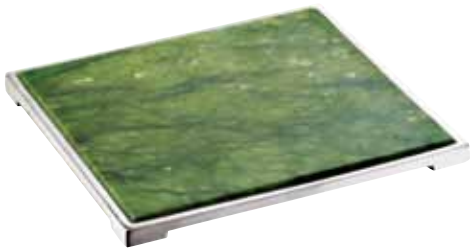

■ NO:181B
方形席面盤 (大)
L245xH25mm



■ NO:181N
毛巾托
L140xW100xH15mm



■ NO:181O
牙籤盒
L110xW50xH28mm



■ NO:180G
更托
φ 708mm



■ NO:181L
彎尾筷子架
L90mm



■ NO:181I
一字筷子架
L60mm



■ NO:181F
牙籤筒
φ 52xH58mm



■ NO:181J
彎形席面更
L192mm



■ NO:181K
直身席面更
L200mm



■ NO:181P
主刀
L225mm



■ NO:181Q
主叉
L200mm



■ NO:181H
筷子
L270mm



■ NO:181M
席巾圈
φ 48xW45mm





■ NO:226A
圓形席面盤
φ 235xH30mm

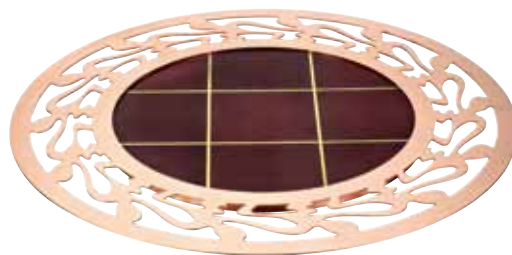

■ NO:226B
花邊圓形席面盤
φ 455mm
φ 320mm



■ NO:226C
方形席面盤
L300xH25mm
L245xH25mm
L200xH25mm



■ NO:226D
經典套裝—瑪瑙盤
L330xW210xH20mm



■ NO:226E
牙籤盒
L110xW50xH28mm



■ NO:226F
牙籤筒
φ 52xH58mm



■ NO:182D1
席巾圈
φ 48xW45mm



■ NO:182C3
彎尾筷子架
L90mm



■ NO:226G
筷子架
L85mm



■ NO:182A4
筷子
L270mm



■ NO:112H2
筷子
L270mm



■ NO:182B5
彎形席面更
L192mm



■ NO:182B6
直身席面更
L200mm



■ NO:226H
主刀
L225mm



■ NO:226I
主叉
L200mm



■ NO:227A
花邊圓形席面盤
φ 455mm
φ 320mm



■ NO:227B
花邊圓形席面盤
φ 455mm
φ 355mm



■ NO:227C
經典套裝—黑瑪瑙盤
L330xW210xH25mm



■ NO:227D
方形席面盤
L300xH15mm
L245xH15mm
L200xH15mm



■ NO:227E
圓形席面盤
φ 235xH30mm



■ NO:227F
煙灰盅
L100xW100xH45mm



■ NO:227G
毛巾托
L140xW100xH15mm



■ NO:227H
牙簽盒
L110xW50xH28mm



■ NO:S-216
席巾圈
φ 48xW45mm



■ NO:227I
筷子架
L85mm



■ NO:S-215
彎尾筷子架
L90mm



■ NO:S-217
筷子
L270mm



■ NO:182A5
圓珠黑瑪瑙
L270mm



■ NO:S-220
直身席面更
L200mm



■ NO:113T1
彎形席面更
L192mm



■ NO:S-218
主刀
L225mm



■ NO:S-219
主叉
L200mm

■ 經典玉石套裝



■ **NO:228A**
 方形席面盤
 L300xH15mm
 L245xH15mm
 L200xH15mm



■ **NO:228B**
 花邊圓形席面盤
 φ 455mm
 φ 320mm

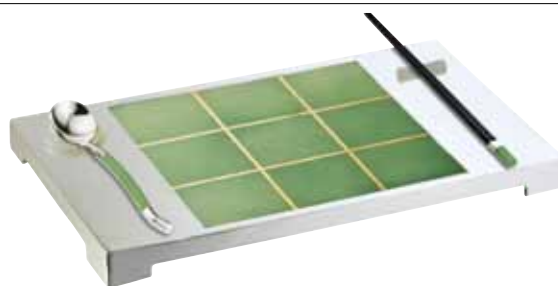

■ **NO:228C**
 經典套裝—黑瑪瑙盤
 L330xW210xH25mm



■ **NO:228D**
 煙灰盅
 L100xW100xH45mm



■ **NO:228E**
 毛巾托
 L140xW100xH15mm



■ **NO:228F**
 牙籤盒
 L90xW65xH25mm



■ **NO:N-151**
 席巾圈
 φ 48xW45mm



■ **NO:228G**
 形筷子架
 L85mm



■ **NO:228H**
 彎尾筷子架
 L90mm



■ **NO:S-175**
 筷子
 L270mm



■ **NO:S-175A**
 筷子(密胺)
 L250mm



■ **NO:228I**
 彎形席面更
 L192mm



■ **NO:228J**
 直身席面更
 L200mm



■ **NO:228K**
 餐刀
 L184mm



■ **NO:228L**
 餐叉
 L210mm



■ NO:229A
經典套裝—瑪瑙盤
L330xW210xH20mm



■ NO:229B
方形席面盤
L300xH15mm
L245xH15mm
L200xH15mm



■ NO:229C
花邊圓形席面盤
φ 455mm
φ 320mm



■ NO:229D
花邊圓形席面盤
φ 455mm
φ 320mm



■ NO:229E
烟灰盅
L100xW100xH45mm



■ NO:229F
牙籤盒
L90xW65xH25mm



NO:229G
毛巾托
L140xW100xH15mm



■ NO:229H
席巾圈
φ 48xW45mm



■ NO:229J
筷子架
L85mm



■ NO:229K
彎尾筷子架
L90mm



■ NO:229L
筷子
L270mm



NO:S-175B
筷子
L270mm



■ NO:229I
筷子架
L90mm



■ NO:229M
彎形席面更
L192mm



■ NO:229N
直身席面更
L200mm



■ NO:229O
餐刀
L184mm



■ NO:229P
餐叉
L210mm



■ **NO:230A**
 方形席面盤
 L300xH15mm
 L245xH15mm
 L200xH15mm

■ **NO:230B**
 經典套裝—彩石盤
 L330xW210xH20mm



■ **NO:230C**
 花邊圓形席面盤
 φ 455mm
 φ 320mm



■ **NO:230D**
 花邊圓形席面盤
 φ 455mm
 φ 320mm



■ **NO:230E**
 煙灰盅
 L100xW100xH45mm



■ **NO:230F**毛巾托
 L140xW100xH15mm



■ **NO:230G**
 牙籤盒
 L90xW65xH25mm



■ **NO:229L**
 筷子
 L270mm



■ **NO:230H**
 席巾圈
 L45xH50mm



■ **NO:229J**
 筷子架
 L85mm



■ **NO:S-175B**
 筷子
 L270mm



盤底可訂造酒店商標



NO:231
夢幻盤
L300xW300xH20mm

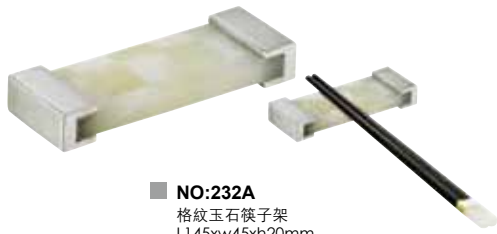

■ NO:232A
格紋玉石筷子架
L145xw45xh20mm



■ NO:232B
格紋玉石毛巾托
L225xW80xH20mm



■ NO:232C
格紋玉石服務盤
L395xW250xH20mm



■ NO:233A
玉石筷子架
L145xw45xh20mm



■ NO:233B
玉石毛巾托
L225xW80xH20mm



■ NO:233C
玉石條形盤
L395xW250xH20mm



■ NO:235A
鑽石貝殼席面盤
L300xH15mm
L245xH15mm
L200xH15mm



■ NO:235B
水滴貝殼席面盤
L300xH15mm
L245xH15mm
L200xH15mm





■ NO:234A
花式貝殼席面盤
φ 455mm
φ 320mm



■ NO:234B
席巾圈
L45xH50mm



■ NO:234C
花式貝殼毛巾碟
L195xW123mm





餐墊系列



香港順誠五金製品廠
SHUNSHING METAL MANUFACTORY

佛山市順創酒店用品有限公司
FOSHAN SHUNCHUANG HOTEL ARTICLES CO.,LTD.



SHUNCHUANG HOTEL ARTICLES



香港順誠五金製品廠
SHUNSHING METAL MANUFACTORY
佛山市順創酒店用品有限公司
FOSHAN SHUNCHUANG HOTEL ARTICLES CO.,LTD.



香港順誠五金制品廠

SHUNSHING METAL MANUFACTORY

佛山市順創酒店用品有限公司

FOSHAN SHUNCHUANG HOTEL ARTICLES CO.,LTD.

本廠創建於本港五金制品興盛的萌芽時期1965年。由當初的老一輩技師手工制作轉而到今天的全機械化模具衝壓，從當初以制作胚身的加工性質到現在集制作生產、表面電鍍處理、開發研制及營銷市場於一身的生產企業實體，專業制作高檔酒店金銀器餐具用品。

為確保產品質量，我們從原料到成品出廠的每一道工序都是自己獨立完成。胚身原料選用日本進口銅，鍍金、鍍銀選用西德金鹽、銀鹽及瑞士純銀條。并堅持不懈地強化產品質量，做好自己的品牌和服務，取信于各國各地客戶，使本廠的生產和業務得以蓬勃發展，成為同行翹首的佼佼者。

為了適應中國內地市場和本廠的發展，我們在中國內地廣東佛山設立了占地面積2萬多平方米的順創五金廚具廠及順創專業金銀器電鍍廠。一直向內地市場推出以SCC為品牌的高檔金銀器餐具用品，更聯合全國各地酒店用品經銷商雄厚的媒介實力，融合自身高品質的制作，實惠的價格、完善的售後服務及龐大的市場作業體系，贏得了廣大客戶的信任和支助，更使SCC品牌的客戶遍布全國各地。

本廠為使本品牌金銀器餐具達到國際水平，不斷添置新機器及先進的電鍍設備，在不斷提升強化現有的鍍金、鍍銀、龍鳳款花金等中式金銀器餐具質量，同時不斷開發出更具皇朝氣派的大滿漢系列，高雅矜貴的貴族彩石、玉石、瑪瑙系列，典雅莊重的錘點系列，適合中、西式國宴的高檔金、銀器餐具用品。

在未來的數年裏我們更會不斷地推陳出新，設計研制更適合市場需求的西式餐飲銀器系列及更適合中國餐飲文化特色的高檔中式金銀器餐具用品，更能使中式金銀器這行業搭配有數千年飲食文化的中菜發揚光大，讓世人所認同。

董事總經理：李應堪先生

Addi Lee

This factory was founded in 1965 in the bud of the period when the hardware works thrived in Hongkong, from the manual manufacture of the technicians of the old generation in the beginning to fully mechanized plunger to day, from processing of manufactured body in the beginning to the productive enterprise entity in integrating manufacture, production, surface-electroplating processing, development & research and marketing into itself, manufacturing professionally the gold and silver tableware utensils of high-grade hotels.

In order to guarantee the quality of products, each process from the raw material to the ex-factory of the finished product is completed by ourselves independently. The raw material of the body is the copper sheets imported from Japan and the gilding and silvering are selected from the sodium gold chloride and silver salt of west Germany and the pure silver strips of Switzerland, strengthening the quality persistently, trying our best to create our own brand and service, obtaining the trust of the clients throughout China so as to facilitate our production and business developing vigorously and become the beloved of the same firm raising their head and looking.

In order to suit the inland market and our development, we have set up Shunchuang Hardware Kitchen Utensils and Shunchuang Professional Gold & Silver Electroplating Factory in Guangdong of China Inland, having always pushed the gold & silver tableware utensils taking SCC as our brand to the inland market of China, combined the rich medium strength of the distributors for the hotel ware throughout China, merged manufacture of our high quality, substantial price, perfect after-sale service and vast market operating system, so as to have won the trust and support of broad clients all over China and the clients all over China and the clients for SCC brand prevailing nationwide.

In order to make our brand gold and silver tableware up to the international level, we have non-stop bought new machinery and advanced electroplating equipment, improved and strengthened non-stop the quality of the existing Chinese gold & silver tableware of gilding, silvering and dragon/phoenix styles /coloured gold, meanwhile, developed non-stop the high-grade gold and silver tableware utensils suiting Chinese and western state banquets such as Da Man Han series with imposing manner of royal dynasty, noble and graceful aristocrat coloured stone, jade and agate series, and graceful and grave hammer-spot series.

In the coming years, we will nonstop weed through the old and bring forth the new, design and develop the western silver tableware series suiting more the demands of the market and the high-grade Chinese gold/silver tableware fitting the Chinese dining/drinking culture, making further Chinese dishes with thousands of years of dining/drinking culture collocated with Chinese gold/silver ware industry to be developed and the people in the world to acknowledge.

順創——頂級餐具制造專家





- P02**
筷子架系列
Chopsticks stand series

P04
筷子系列
Chopsticks series

P06
席面更系列
Self-serving spoon series

P07
不銹鋼刀叉鍍銀系列
Stainless steel knife & fork silvering series

P08
公殼座系列
Soup ladle stand series

P10
服務長更叉系列
Serving spoon & fork series

P11
毛巾碟系列
Towel dish series

P13
洗手盅系列
Washing bowl series

P14
翅碗座系列
Sharks fin soup series

P16
球形翅盅系列
Superior sharkfin stand series

P17
暖翅座系列
Soup warmer stand series

P18
席面碟系列
Show plate series
- P20**
味碟系列
Sauce stand series

P22
圓形器皿系列
Circular utensils series

P24
蛋形器皿系列
Egg utensils series

P25
湯鍋器皿系列
Tang Guo utensil series

P28
服務器皿系列
Serving items series

P32
酒類器皿系列
Serving items series

P34
龍鳳款花金系列
Dragon-phoenix gold pattern series

P44
彩石系列
Colorful stone series

P46
瑪瑙系列
Agate series

P48
臺號座系列
Table number stand series

P49
經典系列
Classical series

P54
經典西式席面盤系列
Classical western-style table plate series
- P56**
酒類銀器皿系列
Silver wine and liquor items series

P60
銅質金銀座酒杯系列
Silver wine liquor items series

P64
洋燭臺系列
Candle stand series

P66
果盤、糕點座系列
Fruit pot pastry stand series

P68
果仁碗/味碟座系列
Nut bowl/sauce stand series

P70
花瓶系列
Flower vase series

P71
席巾圈系列
Napkin ring series

P72
煙灰盅系列
Tobacco ash tray series

P73
服務用銀盤系列
Service uses silver plate series

P74
其它配套系列
Other series

P77
夜總會KTV系列
Club KTV series

P78
仿古餐具系列
Other series



NO:111A1
橋形筷子架
L60mm



NO:111A3
龍頭筷子架
L53mm



NO:111A5
橢圓筷子架
L58mm



NO:111B1
長條四綫筷子架
L70mm



NO:111B2
羅馬筷子架
L80mm

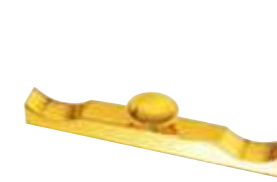

NO:111H2
雙用筷子架
L102mm



NO:111I1
龍形梅花筷子架
L92mm



NO:111I2
龍形筷子架
L92mm



NO:111I3
龍形圓尾筷子架
L95mm



NO:111J1
如意筷子架
L99mm



NO:111B3
枕頭筷子架
L55mm



NO:111B4
長條單綫筷子架
L48mm



NO:111B5
H形筷子架
L39mm



NO:111C1
馬蹄形筷子架
∅47mm × L97mm



NO:111C3
帝皇筷子架
L82mm



NO:111J2
天鵝筷子架
L120mm



NO:111J3
圓座筷子架
L80mm



NO:111J4
錘點三角形筷子架
L78mm



S-120
雙用筷子架
L80



S-121
雙用筷子架
L90



NO:111C5
魚形梅花筷子架
L95mm



NO:111D1
六角形筷子架
L75mm



NO:111D2
蛋形筷子架
L79mm



NO:111D3
磚形筷子架
L73mm



NO:111D4
加侖筷子架
L78mm



S-116A
大鸚鵡公殼座
L130xH60



S-116B
小鸚鵡筷子架
L90xH40



S-127
錘紋筷子架
L80



S-136
合形筷子架
L75



NO:111D5
波板筷子架
L84mm



NO:111E1
皇朝珠脚筷子架
L75mm



NO:111E2
皇朝筷子架
L75mm



NO:111E3
皇朝珠脚筷子架
L75mm



NO:111E4
皇朝筷子架
L75mm



NO:111E5
鯨魚筷子架
L90mm



NO:111F1
神燈筷子架
L70mm



NO:111F2
光身神燈筷子架
L70mm



NO:111F3
蓮花筷子架
L100mm



NO:111F4
光身筷子架
L100mm



NO:111F5
蓮花筷子架
L85mm



NO:111G1
三寶筷子架
L95mm



NO:111G3
浪珠筷子架
L92mm



NO:111G4
浪珠梅花筷子架
L95mm



NO:111H1
雄鷹筷子架
L80mm





NO:112A1
明珠筷子(密胺)
L246mm



NO:112A2
梅蘭菊竹筷子(密胺)
L266mm



NO:112A3
明珠龍鳳筷子(密胺)
L253mm



NO:112A4
龍鳳筷子(密胺)
L266mm



NO:112A5
人字形筷子(密胺)
L269mm



NO:112D1
短珠筷子(密胺)
L255mm



NO:112D2
錘點筷子(密胺)
L263mm



NO:112D3
尖膠頭龍鳳筷子(密胺)
L272mm



NO:112D4
尖膠頭三綫筷子(密胺)
L272mm



NO:112D5
尖膠頭梅蘭菊竹筷子(密胺)
L272mm



NO:112B1
羅馬筷子(密胺)
L266mm



NO:112B2
三綫筷子(紅木)
L270mm



NO:112B3
龍鳳筷子(紅木)
L273mm



NO:112B4
三綫筷子(密胺)
L266mm



NO:112B5
明珠光身筷子(紅木)
L261mm



NO:112E1
長珠筷子(密胺)
L254mm



NO:112E2
明珠筷子(密胺)
L248mm



NO:112E3
短雙綫筷子(密胺)
L252mm



NO:112E4
光身筷子(密胺)
L255mm



NO:112E5
彩石筷子(密胺)
L250mm



NO:112C1
梅蘭菊竹筷子(紅木)
L273mm



NO:112C2
雙十綫筷子(密胺)
L265mm



NO:112C3
拉綫筷子(密胺)
L272mm



NO:112C4
花金筷子(密胺)
L266mm



NO:112C5
雙綫筷子(密胺)
L263mm



NO:182A4
圓珠紅瑪瑰
L270mm



NO:182A5
圓珠黑瑪瑰
L270mm



NO:182A6
圓珠綠瑪瑰
L270mm



NO:112F4
玉石筷子
L270mm



NO:112F5
紫羅紅筷子
L270mm



所有產品均采用臺灣進口密胺筷子身品
種有：密胺黑、象牙白、翡翠綠、磨砂高
檔黑、棗紅密胺、進口紫檀木、紅木。
“以上產品均可按客戶要求壓制標嘜，
亦可按客戶要求訂造各種款式。”



NO:112G1
光身密胺筷子(輕盈)
L250mm



NO:112G2
綫條紫檀木筷子(輕盈)
L250mm



NO:112G3
全鋼筷子
L253mm



NO:112G4
全鋼花筷子
L226mm



NO:112G5
全鋼花筷子(花金)
L226mm



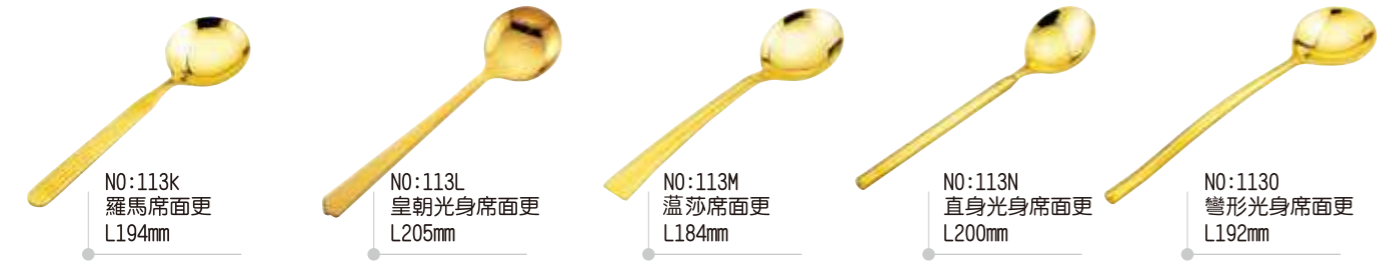

明珠不銹鋼鍍銀系列



公爵不銹鋼花金系列



NO:114A
龍形公殼座
L133mm



NO:114B
梅花龍形公殼座
L133mm



NO:114C
皇朝珠腳公殼座
L100mm



NO:114D
皇朝平底公殼座
L100mm



NO:114E
三寶梅花公殼座
L153mm



NO:114F
三寶公殼座
L160mm



NO:114G
鯨魚公殼座
L142mm



NO:114H
魚形公殼座
L130mm



NO:114I
磚形公殼座
L100mm



NO:114J
羅馬公殼座
L112mm



NO:114K
神燈公殼座
L110mm



NO:114L
蓮花公殼座
L147mm



NO:115A
龍形大公殼
L382mm



NO:115B
龍形細公殼
L274mm



NO:115C
龍形湯篩(大)
L382mm



NO:115D
皇朝大公殼
L370mm



NO:115E
皇朝細公殼
L272mm



NO:115F
明珠大公殼
L395mm



NO:115G
明珠細公殼
L253mm



NO:115H
三寶大公殼
L385mm



NO:115I
三寶細公殼
L259mm



NO:115J
佛笑柄大公殼
L385mm



NO:115K
佛笑柄細公殼
L260mm



NO:115L
錘點大公殼
L395mm



NO:115M
錘點細公殼
L253mm





NO:116A1
龍形長更
L230mm

NO:116A2
龍形長叉
L228mm



NO:116B1
皇朝長更
L226mm

NO:116B2
皇朝長叉
L226mm



NO:116C1
三寶長更
L228mm

NO:116C2
三寶長叉
L223mm



NO:116D1
明珠長更
L228mm

NO:116D2
明珠長叉
L225mm



NO:116E1
龍柄餐刀
L199mm

NO:116E2
龍柄餐叉
L199mm

NO:116F
錘點茶更
L155mm



NO:116G
不銹鋼汁更
L192mm

NO:116H
不銹鋼汁更
L220mm



NO:116I 竹節柄餐刀 L210mm

NO:116J 竹節柄餐叉 L193mm

NO:116K 竹節柄大更 L188mm

NO:116L 竹節柄細更 L140mm



銅質竹節系列



NO:117A
光身毛巾碟
3 × 5 L132 × W95 (mm)
4 × 5 L126 × W100 (mm)
4 × 6 L155 × W104 (mm)



NO:117B1
燒珠邊毛巾碟(龍鳳)
3 × 5 L130 × W95 (mm)
4 × 5 L125 × W100 (mm)
4 × 6 L148 × W103 (mm)



NO:117B2
壓珠邊毛巾碟(龍鳳)
3 × 5 L135 × W99 (mm)
4 × 5 L132 × W104 (mm)
4 × 6 L155 × W108 (mm)



NO:117C1
燒加侖邊毛巾碟
3 × 5 L125 × W100 (mm)
4 × 5 L130 × W94 (mm)
4 × 6 L146 × W101 (mm)



NO:117C2
壓加侖邊毛巾碟
3 × 5 L132 × W94 (mm)
4 × 5 L132 × W100 (mm)
4 × 6 L155 × W108 (mm)

NO:117D
海棠毛巾碟
L125 × W95 (mm)



NO:117E
毛巾碟
L130 × W84 (mm)



NO:117F
蛋形毛巾碟
L144 × W108 (mm)

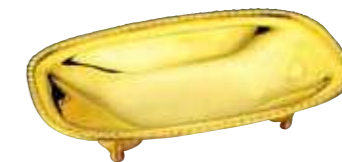

NO:117G
船形毛巾碟
L212 × W130 (mm)



NO:117H
條形加侖邊毛巾碟
L193 × W83 (mm)



NO:117I
條形光身毛巾碟
L193 × W83 (mm)



NO:117J
條形珠邊毛巾碟
L193 × W83 (mm)



NO:117K
雲龍毛巾盒
L223 × W141 × H121



NO:117L
錘點毛巾碟
L157 × W64 (mm)



NO:117M
錘點毛巾碟
L115 × W64 (mm)



NO:117N
錘點毛巾碟
(大) L130 × W65 (mm)
(小) L110 × W62 (mm)



NO:117O
錘點毛巾碟
L241 × W119



NO:117P
光身毛巾碟
L157 × W64 (mm)



NO:117Q
光身毛巾碟
L115 × W64 (mm)



NO:117R
光身毛巾碟
(大) L130 × W65 (mm)
(小) L110 × W62 (mm)



NO:117S
錘點毛巾碟
3 × 5 L132 × W95 (mm)
4 × 5 L126 × W100 (mm)
4 × 6 L155 × W104 (mm)



NO:117T
錘點毛巾碟
3 × 5 L132 × W95 (mm)
4 × 5 L126 × W100 (mm)
4 × 6 L155 × W104 (mm)

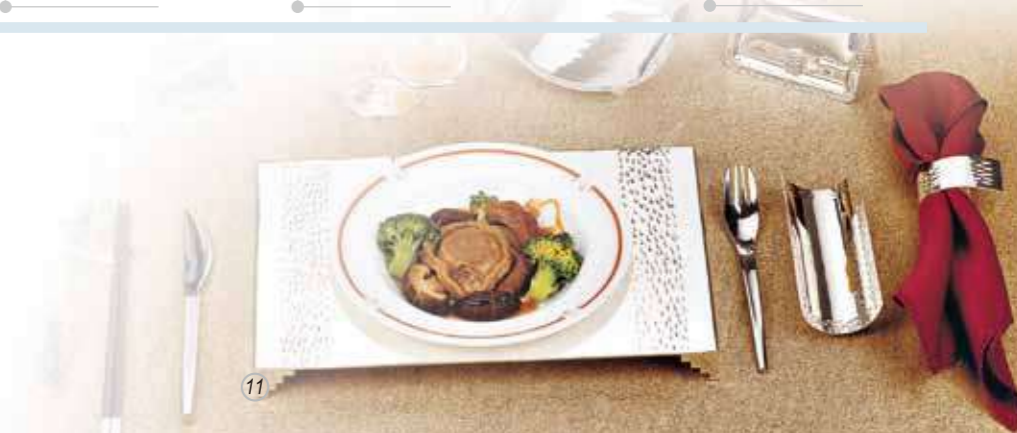



NO:168A
瓣形洗手盅
Ø125 × H50 (mm)



NO:168A1
瓣形洗手盅底碟
Ø158 (mm)



NO:168B
碗形洗手盅
Ø117 × H44 (mm)



NO:168B1
碗形洗手盅底碟
Ø140 (mm)



NO:168C
綫條洗手盅
Ø110 × H45 (mm)



NO:168C1
綫條洗手盅底碟
Ø140 (mm)



NO:168D
錘點洗手盅
Ø115 × H44 (mm)



NO:168D1
錘點洗手盅底碟
Ø140 (mm)



NO:168E
滿漢洗手盅
Ø124 × H70 (mm)



NO:168E1
滿漢洗手盅底碟
Ø158 (mm)



翅碗座系列
Sharks fin soup series



NO:118J
滿漢龍耳翅碗
Ø103mm × H64 (mm)



NO:118K
滿漢龍耳帶蓋翅碗
Ø113mm × H121 (mm)



NO:118L/118M
錘點三寶翅碗/底碟
Ø103 × H60/



NO:118D
翅碗底碟
Ø167mm × H33 (mm)



NO:118E
翅碗底碟
Ø155 × H33



NO:118F
三寶翅碗
Ø103mm × H60 (mm)



NO:118G
魚形翅碗
Ø103mm × H60 (mm)



NO:118H
珠耳翅碗
Ø103mm × H60 (mm)



NO:118I
皇朝翅碗
Ø103mm × H60 (mm)



NO:118A
龍耳翅碗
Ø103mm × H60 (mm)



NO:118B
龍耳翅碗(壓珠邊)
Ø103mm × H60 (mm)



NO:118C
龍耳翅碗帶蓋
Ø116mm × H115 (mm)



大滿漢金、銀器系列乃本廠首屈一指的又一精心之作，雕工精細，龍飛鳳舞，每一件制品都是技師精心之作



大滿漢系列



每位火窩系列



NO:119A
球形翅盅(龍鳳)
Ø132mm × H130 (mm)



NO:119B
球形翅盅(皇朝)
Ø132mm × H130 (mm)



NO:119C
球形翅盅(三寶)
Ø132mm × H130 (mm)



NO:119D
球形翅盅(明珠)
Ø132mm × H130 (mm)



NO:119E
滿漢鮑翅盅連底碟(每位用)
SUEME SHARRSFINSOUP BOWL/COVER/UNDERLINER
Ø125mm × H134 × L210 (mm)
Ø183 × H30 (mm) (底碟)



NO:119F
蓋式球形翅盅
Ø132mm × H160 (mm)



NO:119G
球形翅盅底碟(龍鳳)
Ø217mm



NO:119H
球形翅盅底碟(綫條)
Ø195mm



NO:119I
錘點球形翅盅/底碟
Ø132 × H130 (mm) / Ø217mm



NO:120C



NO:120E
每位魚翅碗連匙
玻璃Ø104 × 50 (mm)



NO:120A



NO:120B



編號 CODE	暖湯座(英寸) SOUP WARMER	外Ø (mm)	內Ø (mm)	H (mm)	暖湯座底碟 SOUP WARMER UNDERLINR	
					(英寸)	Ø (mm)
120A ₁	4-1/2"	115	98	95	7"	183
120A ₂	5"	126	111	92	7-1/2"	194
120A ₃	6"	152	132	93	8-1/2"	215
120A ₄	7"	175	156	92	9"	255
120A ₅	8"	204	194	90	10"	311

編號 CODE	暖湯座(英寸) SOUP WARMER	外Ø (mm)	內Ø (mm)	H (mm)	暖湯座底碟 SOUP WARMER UNDERLINR	
					(英寸)	Ø (mm)
120B ₁	4-1/2"	115	98	95	7"	183
120B ₂	5"	126	111	92	7-1/2"	194
120B ₃	6"	152	132	93	9"	232
120B ₄	7"	175	156	92	10"	255
120B ₅	8"	204	194	90	12"	311

編號 CODE	暖湯座(英寸) SOUP WARMER	外Ø (mm)	內Ø (mm)	H (mm)	暖湯座底碟 SOUP WARMER UNDERLINR	
					(英寸)	Ø (mm)
120C ₁	5"	124	108	92	7.5"	194





NO:121A
壓珠邊席面碟
6½" (外∅156 × 內∅115)mm
7" (外∅180 × 內∅140)mm
7½" (外∅192 × 內∅140)mm
8" (外∅205 × 內∅150)mm
8½" (外∅220 × 內∅150)mm



NO:121B
龍鳳壓珠邊席面碟
6½" (外∅156 × 內∅115)mm
7" (外∅180 × 內∅140)mm
7½" (外∅192 × 內∅140)mm
8" (外∅205 × 內∅150)mm
8½" (外∅220 × 內∅150)mm



NO:121C
錘點壓珠邊席面碟
6½" (外∅156 × 內∅115)mm
7" (外∅180 × 內∅140)mm
7½" (外∅192 × 內∅140)mm
8" (外∅205 × 內∅150)mm
8½" (外∅220 × 內∅150)mm



NO:121J
錘點八角席面碟
外∅200 × 內∅160 (mm)



NO:121K
錘點席面碟
外∅260 × 內∅230 (mm)



NO:121L
錘點席面碟
大: ∅330mm
中: ∅255mm
小: ∅160mm



NO:121D
加侖邊席面碟
6" (外∅148 × 內∅115)mm
6½" (外∅165 × 內∅115)mm
7" (外∅180 × 內∅140)mm
7½" (外∅290 × 內∅140)mm
8" (外∅203 × 內∅150)mm
8½" (外∅220 × 內∅150)mm



NO:121E
龍鳳加侖邊席面碟
6" (外∅148 × 內∅115)mm
6½" (外∅165 × 內∅115)mm
7" (外∅180 × 內∅140)mm
7½" (外∅290 × 內∅140)mm
8" (外∅203 × 內∅150)mm
8½" (外∅220 × 內∅150)mm



NO:121F
錘點席面碟
6" (外∅148 × 內∅115)mm
6½" (外∅165 × 內∅115)mm
7" (外∅180 × 內∅140)mm
7½" (外∅290 × 內∅140)mm
8" (外∅203 × 內∅150)mm
8½" (外∅220 × 內∅150)mm



NO:121M
加侖邊席面碟
9" (外∅230 × 內∅182)mm
11" (外∅282 × 內∅230)mm



NO:121N
光身加侖邊席面碟
6" 6½"
7" 7½"
8" 8½"
9" 10" 12"



NO:121O
蛋形席面碟
L275 × W183 (mm)



NO:121G
光身燒珠邊席面碟
9" (外∅230 × 內∅175)mm
10" (外∅255 × 內∅190)mm
12" (外∅300 × 內∅260)mm



NO:121H
光身綫條席面碟
6" 6½"
7" 7½"
8" 8½"
9" 10" 12"



NO:121I
光身洋花席面碟
6" 6½"
7" 7½"
8" 8½"
9" 10" 12"



NO:121P
震珠邊席面碟
7-1/2" (外∅195 × 內∅165)mm



NO:121Q
三腳壓珠邊席面碟
6" 6½"
7" 7½"
8" 8½"
9" 10" 12"



NO:121R
八角席面碟
(外∅200 × 內∅160)mm



NO:122A
圓形三腳味碟
Ø125 × H27 (mm)



NO:122B
圓形高莊味碟
Ø125 × H73 (mm)



NO:122C
方形四腳味碟
Ø113 × H56 (mm)



NO:122D
方形高莊味碟
Ø113 × H84 (mm)



NO:122E
圓形三腳味碟 (綫條)
Ø126 × H25 (mm)



NO:122F
圓形高莊味碟 (綫條)
Ø126 × H65 (mm)



NO:122G
圓形三腳味碟 (光身)
Ø120 × H25 (mm)



NO:122H
圓形高莊味碟 (光身)
Ø126 × H65 (mm)



NO:122I
錘點圓形三腳味碟
Ø126 × H25 (mm)



NO:122J
錘點圓形高莊味碟
Ø125 × H65 (mm)



NO:123
飯碗蓋
RICE BOWL COVER
Ø116 × H55 (mm)

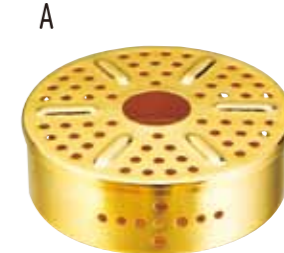

NO:124A
暖茶座
TEA POT WARMER
Ø152 H56mm



NO:124B
茶壺咀
SPOUT (TEAPOT)



NO:125
南瓜盅
PUMPKIN CUP
Ø122 × H105 (mm) / 底碟 Ø65mm



NO:126
暖茶座
DIM SUM BASKET
Ø150 × H80mm



NO:127
木瓜盅 (每位用)
PAPAYA SOUPSTAND
L160 × W130 × H56 (mm)



NO:128
點心籠
DIM SUM BASKET
6# Ø165 × H75 (mm)



NO:129A
響螺碟莊連蓋
L225 × W170 × H140 (mm)

NO:S-199
通花暖茶座/暖茶座連底碟
Ø156xH45



129C
每位山海火窩煲
H155mm Ø153mm



129D
每位火窩煲 (配9"底碟)
L227 H220mm Ø195mm



129E
每位火窩煲
H190mm Ø160mm

● 以上兩款可燃蠟或酒精



NO:131
圓形碟托



NO:B131
錘點圓形碟托

圓形碟托			
編號	ROUND PLATTER HOLDER	Ø mm	Hmm
131A	7 × 8"	200/222	65
131B	9 × 10"	230/250	75
131C	10 × 12"	260/285	80
131D	12 × 14"	285/314	85
131E	14 × 16"	355/385	95



NO:132
圓形碟托連爐架



NO:C132
錘點圓形碟托連爐架

圓形碟托連爐架			
編號	ROUND PLATTER HOLDER	Ø mm	Hmm
132A	7"	200	65
132B	9"	230	75
132C	10"	260	80
132D	12"	285	85
132E	14"	355	95



NO:130
圓形三脚碟座



NO:A130
錘點圓形三脚碟座

圓形三脚碟座			
編號	ROUND-PLATTER	Ø mm	Hmm
130A	8"	205/165	40
130B	9"	238/185	50
130C	10-1/2"	270/215	60
130D	11-1/2"	290/240	60
130E	13"	330/265	60
130F	15"	400/320	85
130G	17"	430/360	85
130H	18"	465/360	85
130I	20"	510/410	85



NO:133
圓形龍鳳蓋



NO:D133
錘點圓蓋

圓形龍鳳蓋			
編號	ROUND-COVER	Ø mm	Hmm
133A	6-1/2"	165	55
133B	7-1/2"	190	60
133C	8-1/2"	205	65
133D	9-1/2"	245	75
133E	10-1/2"	270	85
133F	11-1/2"	295	95
133G	13"	335	100
133H	15"	385	105
133I	17"	435	105



NO:134
蛋形碟座
OVAL PLATE



NO:A134
錘點蛋形碟座

蛋形碟座				
編號	OVAL-PLATTER	Lmm	Wmm	Hmm
134A	9"	230/180	180	40
134B	11"	280/210	222	45
134C	13"	330/255	245	45
134D	15"	390/310	310	65
134E	17"	435/360	340	70
134F	20"	510/420	390	75
134G	22"	560/470	440	85



NO:135
蛋形碟托
OVAL PLATE HOLDER



NO:B135
錘點蛋形碟托

蛋形碟托				
編號	OVAL-PLATTER HOLDER	Lmm	Wmm	Hmm
135A	7 × 8"	167/190	130/150	60
135B	9 × 10"	195/210	145/165	70
135C	10 × 12"	245/260	160/180	75
135D	12 × 14"	275/305	185/220	75
135E	14 × 16"	345/360	225/250	85
135F	16 × 18"	380/395	255/265	90



NO:136
蛋形碟托連爐架
OVAL PLATE HOLDER W/WARMERL



NO:C136
錘點蛋形碟托連爐架

蛋形碟托連爐架				
編號	OVAL PLATTER HOLDER	Lmm	Wmm	Hmm
136A	7"	167	130	60
136B	9"	195	145	60
136C	10"	245	160	75
136D	12"	275	185	75
136E	14"	345	225	85
136F	16"	380	255	90



NO:137
蛋形龍鳳蓋
OVAL COVER



NO:D137
錘點蛋形蓋

蛋形龍鳳蓋				
編號	OVAL COVER	Lmm	Wmm	Hmm
137A	8"	200	150	55
137B	9"	210	160	55
137C	10"	250	180	70
137D	12"	300	215	80
137E	14"	330	240	80
137F	16"	400	300	90
137G	18"	450	310	90
137H	20"	510	390	120



NO:138
A1:8-10位龍耳翅窩 PERSONS SHARKSFIN TUREEN
L:400 × Ø265 × H100 (mm)
A2:10-12位龍耳翅窩 persons sharksfin tureen
L:475 × Ø300 × H125 (mm)



NO:139
A1:8-10位挽手腰身翅窩 SHARKSFIN SOUP TUREEN SET
L:365 × Ø270 × H100 (mm)
A2:10-12位 挽手腰身翅窩
L:400 × Ø305 × H105 (mm)



NO:140
醉蝦窩 DRUNKENSHRMP CASSEROLE
A:Ø275 × L330 × H60mm
B:Ø305 × L362 × H65mm



NO:141
三寶錘點翅窩
8-10 位 L400 × Ø265 × H100mm
10-12位 L475 × Ø300 × H125mm





NO:142
火窩鴨皮爐
Ø 231 × H156mm



NO:144
蛇窩暖座連架 SNAKE SOUP SET
身: A Ø 275 × H62mm
B Ø 320 × H70mm
架: A Ø 245 × 165mm
B Ø 290 × 165mm



NO:145
冬瓜盅 MELON SOUP HOLDER
A: Ø 216 × H335mm
B: Ø 250 × H370mm



NO:146
鮑魚窩莊 ABALONE DISH STAND
11" Ø 270 × H73mm
12" Ø 300 × H75mm
13" Ø 332 × H75mm



NO:147
沙窩煲 CASSE ROLE STAND
4#L210 × W175mm 5#L290 × W230mm
6#L300 × W260mm 7#L330 × W270mm



NO:143
大滿漢冬瓜盅





NO:148A
四脚猪形碟莊 SUCKLING PIG PLATTER W/4 LEGS
L560 × 345 × H90mm



NO:148B
錘點四脚猪形碟莊



NO:152A
毛巾籃連夾
TOWEL BASKET W/TONG
大:L320 × W240 × H90 (mm) A₁ L200mm
細:L240 × W157 × H68 (mm) A₂ L130mm



NO:153
龍柄分魚刀叉連盤
FISH KNIFE&FORK W/TRAY
A:L370 × W233 × H78mm
B:龍柄分魚刀:L282mm
C:龍柄分魚叉:L298mm



NO:149A
17"果盤/四格玻璃轉盤
∅460 × H80mm



NO:149B
錘點果盤/四格玻璃轉盤



NO:152B
毛巾籃連夾
TOWEL BASKET W/TONG
L320 × W240 × H90 (mm) B₁ L250mm



NO:0-107
服務盤
L260xW260xH195



NO:150潮州轉盤
REVOLVING TEOCHEW DISH HOLDER
15" ∅400 × H80mm
17" ∅460 × H80mm
五格玻璃 300mm



NO:151每位鮑魚碟連蓋
PLATE WITH COVER
碟: ∅223/∅170m
蓋: ∅165m



NO:152C
錘點毛巾籃連夾
L320 × W240 × H90 (mm)
C₁ L200mm





NO:156
山瑞莊 TURTEL STAND
L500 × W350 × H130mm



NO:158
A1:四頭龍柱轉莊 L650 × H430mm
A2:兩頭龍柱轉莊 L650 × H430mm
2ARMS/4AMS REVOLVNG DISH STAND (DRAGON)



NO:157
壽司船 DRAGON BOAT
L730 × W210 × H315 (mm)



NO:159
A1:四頭花柱轉莊 L669 × H430mm
A2:兩頭龍柱轉莊 L669 × H430mm
2ARMS/4AMS REVOLVNG DISH STAND (DRAGON)

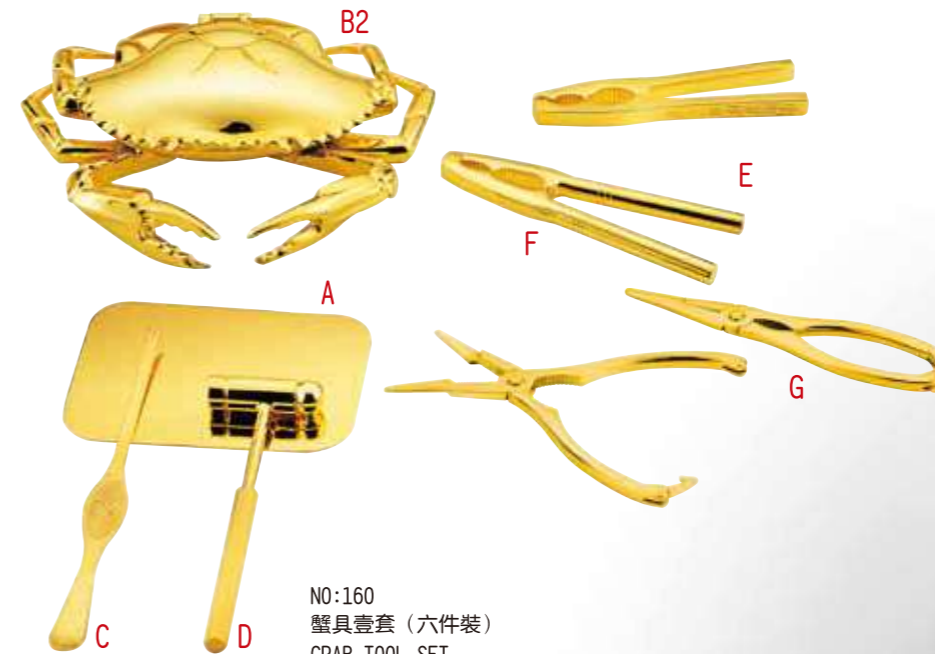

NO:160
蟹具壹套 (六件裝)
CRAB TOOL SET
A蟹墊板L130 × W100 (mm)
B1大蟹形座L200x165 (mm)
B2小蟹形座L160x160 (mm)
C蟹針 L200mm
D蟹錘 L160mm
E蟹鉗 (方柄) L163mm
F蟹鉗 (圓柄) L172mm
G蟹剪 L185mm





NO:161
A1 細鳳咀花雕酒壺
H201mm ML500
B1 白酒杯 H65mm



NO:161
A2 大鳳咀花雕酒壺
H253mm ML930
B2 花雕酒杯
H75mm



NO:162A
細鳳咀花雕酒壺座
L182 × W134 × H71mm



NO:162B
大鳳咀花雕酒壺座
L242 × W152 × H75mm



NO:163A
滿漢大鳳咀花雕酒壺
H253mm ML930



N:163B
滿漢細鳳咀花雕酒壺
H201mm ML500



NO:165A
龍耳香檳酒桶
∅220 × H220 (mm)
WINE COOLER



NO:165B
大滿漢香檳酒桶
∅210 × H225 (mm)



NO:166A
龍柱香檳酒架
∅190mm
H700mm
∅240mm



NO:166B
大滿漢龍柱香檳酒架



NO:164A
大滿漢酒壺座(細)
L182 × W134 × H71mm



NO:164B
滿漢酒壺座(大)
L242 × W152 × H75mm



NO:164C
大滿漢深莊酒壺座
L198 × W136 × H120mm



NO:167A
龍耳冰桶
∅150 × H132 (mm)
冰夾:L200 (mm)



NO:167B
大滿漢龍耳冰桶
∅128 × H144 (mm)



備注：以下各款花金系列之尺寸可參考鍍金銀圖片

REMARK: For other sizes of sizes of silverplated w/gild pattern (Dragon&phoenix design), please refer to the silverplated picture.



菊花席巾圈



彈簧席巾圈



彈簧蟹爪形席巾圈



間金席巾圈



金絲結席巾圈



通花席巾圈



星形席巾圈



龍形筷子架



如意筷子架

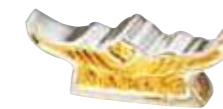

冠形筷子架



天鵝筷子架



龍形席面更



皇朝席面更



三綫筷子



珠邊毛巾碟



條形珠邊毛巾碟



條形加扁邊毛巾碟



龍形大公殼



龍形公殼座



珠邊席面碟



龍耳翅碗



翅碗底碟



滿漢龍耳翅碗



蛋形碟座



蛋形龍鳳蓋



滿漢龍耳翅碗帶蓋



魚形翅碗



暖翅座連底碟



圓形三脚碟座



圓形龍鳳蓋



球形翅盅連底碟



滿漢翅盅連底碟 (每位用)



A 大滿漢龍耳翅窩
B 龍耳翅窩



A 大滿漢挽手腰身翅窩
B 挽手腰身翅窩





大滿漢冬瓜盅



蛋形碟托



NO:170
大滿漢圓形三脚碟座
大: $\varnothing 590 \times \varnothing 412$ (mm)
小: $\varnothing 462 \times \varnothing 320$ (mm)



NO:171
圓形龍鳳蓋
17": $\varnothing 435$ (mm)
13": $\varnothing 335$ (mm)



冬瓜盅



毛巾藍連夾



NO:172
大滿漢蛋形碟座
大: 外 $\varnothing 622 \times$ 內 $\varnothing 470 \times$ W500 (mm)
小: 外 $\varnothing 512 \times$ 內 $\varnothing 360 \times$ W390 (mm)



NO:173
蛋形龍鳳蓋
20": $\varnothing 510$ (mm)
16": $\varnothing 400$ (mm)



龍柄餐叉

每位鮑翅碟連蓋

龍柄餐刀



NO:169
A:大滿漢四脚猪形碟莊
B:四脚猪形碟莊



雙龍酒座



39



NO:174
龍蝦盤
L840 \times W440 (mm)

38



圓形三脚味碟



NO:175
龍頭暖茶座
Ø163 × L246 × H81 (mm)



每款花金座酒杯



大滿漢大花雕酒壺連座



大滿漢大花雕酒壺



大滿漢細花雕酒壺



魚形醬汁架



竹節形牙籤筒



杯形牙籤筒



彈簧夾臺號座



魚形烟灰碟



大滿漢龍柱香檳酒架



大滿漢香檳酒桶



大滿漢冰桶



滿漢洗手盅



碗形洗手盅連底碟



NO:176
滿漢洗手盅
Ø145 × H77 (mm)



NO:177
烟盒
L245 × W105 × H28 (mm)



NO:178
紙巾盒
L246 × W131 × H92 (mm)



NO:180A
圓形席面盤
Ø235 × H30 (mm)

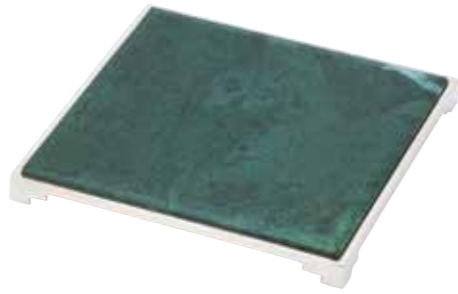

NO:180B
方形席面盤 (大)
L245 × H25 (mm)

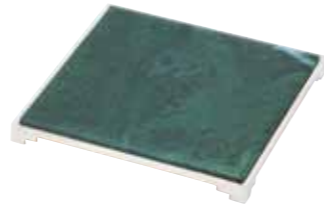

NO:180C
方形席面盤 (小)
L200 × H25 (mm)



NO:180D
經典套裝 - 彩石盤
L330 × W210 × H20 (mm)



NO:180E
扇形席面盤
L320 × H185 (mm)



NO:180F
牙籤盒
L110 × W50 × H28 (mm)



NO:180G
牙籤筒
Ø52 × H58 (mm)



NO:180H
更托
Ø70 (mm)



NO:180I
筷子
L270 (mm)



NO:180J
一字筷子架
L60 (mm)



NO:180K
直身席面更
L200 (mm)



NO:180L
彎形席面更
L192 (mm)



NO:180M
彎尾筷子架
L90 (mm)



NO:180N
席巾圈
Ø48 × W45 (mm)



NO:181A
圓形席面盤
Ø235 × H30 (mm)



NO:181B
方形席面盤 (大)
L245 × H25 (mm)



NO:181C
經典套裝 - 玉石盤
L330 × W210 × H20 (mm)



NO:181D
方形席面盤 (小)
L200 × H25 (mm)



NO:181E
牙籤盒
L110 × W50 × H28 (mm)



NO:181F
牙籤筒
Ø52 × H58 (mm)



NO:181G
更托
Ø70 (mm)



NO:181H
筷子
L270 (mm)



NO:181I
一字筷子架
L60 (mm)



NO:181J
彎形席面更
L192 (mm)



NO:181K
直身席面更
L200 (mm)



NO:181L
彎尾筷子架
L90 (mm)



NO:181M
席巾圈
Ø48 × W45 (mm)



NO:182D1

NO:182T1

NO:182T2

NO:182B5

NO:182A4



NO:182A1
黑瑪瑙
L270 (mm)

NO:182A2
紅瑪瑙
L270 (mm)

NO:182A3
綠瑪瑙
L270 (mm)

NO:182A4
圓珠紅瑪瑙
L270 (mm)

NO:182A5
圓珠黑瑪瑙
L270 (mm)

NO:182A6
圓珠綠瑪瑙
L270 (mm)



NO:182B1
黑瑪瑙彎更
L192 (mm)

NO:182B2
黑瑪瑙直更
L200 (mm)

NO:182B3
綠瑪瑙彎更
L192 (mm)

NO:182B4
綠瑪瑙直更
L200 (mm)

NO:182B5
紅瑪瑙彎更
L192 (mm)

NO:182B6
紅瑪瑙直更
L200 (mm)



NO:182C1
黑瑪瑙彎尾筷子架
L90 (mm)



NO:182C2
綠瑪瑙彎尾筷子架
L90 (mm)



NO:182C3
紅瑪瑙彎尾筷子架
L90 (mm)



NO:182D1
紅瑪瑙席巾圈
Ø40 × W40 (mm)



NO:182D2
黑瑪瑙席巾圈
Ø40 × W40 (mm)



NO:182D3
綠瑪瑙席巾圈
Ø40 × W40 (mm)





NO:185A
臺牌座
L130 × W80 × H70 (mm)



NO:185B
臺牌座
L132 × W105 × H65 (mm)



NO:185C
臺牌座
L132 × W105 × H65 (mm)



NO:185D
旋轉臺牌座
L190 × H185 (mm)



NO:185E
彈簧夾臺號座
H120 (mm)



NO:185F
臺號座
H205 (mm)



NO:185G
臺號座
H90 (mm)



NO:185H
臺號座
∅120 × H530 (mm)



NO:185I
臺號座
∅102 × H380 (mm)
∅120 × H480 (mm)



NO:185J
臺號座
∅109 × H435 (mm)



NO:185K
臺號座
∅90 × H380 (mm)



三寶款

金、銀器餐具在古代作為一種盛器被皇權貴族視為財富與身份的象征，透視出一個朝代的繁華發展，凝聚着古代人民的智慧與靈感，今天我們用先進科技融會古代人們的精華，重新塑造奢華的金、銀器餐具。



皇朝款 DELUXE PATTERN

一件銀器餐具有品，只要它的銀鍍層達到標準的厚度，及了解使用時的簡單清潔保養，就可以使用很長的時間，為用戶帶來真正的效益。



KTV 廂房專用品

錘點銀器KTV包房專用品，是本廠專門針對各星級KTV包房而研制，已成為各星級酒店KTV包房互相攀比、追捧的熱門用品。



錘點系列

錘點銀器餐具有品，融中式的大氣以及西式的優雅，是本廠又一最新研制的整套系列，正成為各大五星級酒店的首選餐桌用品，其不易劃損，使它在使用上有着很大的優點。



綠彩石經典套裝

鑲嵌彩石、玉石瑪瑙銀器用品系列，高貴典雅，
成為各大五星級酒店極具奢華的桌面用品。



溫莎系列
WINDSOR SERIES



夢巴黎錘印系列
Paris dream hammered stamp series



皇室宴會花金系列
THE BANQUE COLOURED GOLD OF IMPERIAL FAMILY IS SERIES



豪爵系列
HAO JUE SERIES



NO:186A1
皇室花金席面碟
Ø318 Ø210 (mm)



NO:186A2
皇室花金席面碟
Ø210 Ø150 (mm)



NO:186B1
夢巴黎錘印席面碟
Ø331 Ø248 (mm)



NO:186B2
夢巴黎錘印席面碟
Ø180 Ø138 (mm)



NO:186C1
豪爵席面碟
L300 Ø205mm



NO:186C2
豪爵席面碟
L200 Ø160 (mm)



NO:186D1
瀟沙席面碟
Ø310 Ø210 (mm)



NO:186D2
瀟沙席面碟
Ø226 Ø160 (mm)



NO:186E1
錘點席面碟
Ø310 Ø210 (mm)



NO:186E2
錘點席面碟
Ø226 Ø160 (mm)



NO:187A
皇室花金圓頂餐碟蓋
8" Ø 220 H130 (mm)
10" Ø 265 H175 (mm)
12" Ø 310 H180 (mm)



NO:187B
花金龍紋圓頂西餐碟蓋
10" Ø 265 H175 (mm)



NO:187C
夢巴黎錘印圓頂餐碟蓋
8" Ø 220 H130 (mm)
10" Ø 265 H175 (mm)
12" Ø 310 H180 (mm)



NO:187D
瀟沙圓頂光身餐碟蓋
8" Ø 220 H130 (mm)
10" Ø 265 H175 (mm)
12" Ø 310 H180 (mm)



NO:187E
豪爵圓頂光身餐碟蓋
8" Ø 220 H130 (mm)
10" Ø 265 H175 (mm)
12" Ø 310 H180 (mm)



NO:187F
豪爵錘點圓頂餐碟蓋
8" Ø 220 H130 (mm)
10" Ø 265 H175 (mm)
12" Ø 310 H180 (mm)



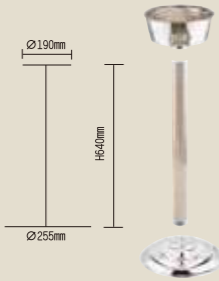

NO:188A
花柱香檳酒架
Wine cooler stand



NO:188B
光柱香檳酒架
Wine cooler stand



NO:189A
獅頭香檳酒桶
Ø220 H220 (mm)



NO:189B
獅頭冰桶
ICE BUCKET
Ø150 × H132 (mm)



NO:188C
三脚酒架
H610 Ø216



NO:189C
皇朝香檳酒桶
CHAMPAGNE BUCKET
Ø220 × H220 (mm)



NO:189D
皇朝冰桶
ICE BUCKET
Ø150 × H132 (mm)



NO:189E
三翼香檳酒桶
CHAMPAGNE BUCKET
Ø220 × H220 (mm)



NO:189F
三翼冰桶
ICE BUCKET
Ø150 × H132 (mm)



NO:189G
明珠香檳酒桶
CHAMPAGNE BUCKET
Ø220 × H220 (mm)



NO:189H
明珠冰桶
ICE BUCKET
Ø150 × H132 (mm)





NO:190A
圓珠三腳冰盤 (錘點)
小 Ø 220 × H100 (mm)
中 Ø 265 × H145 (mm)
大 Ø 310 × H150 (mm)



NO:K-105
冰桶
Ø150xH180



NO:K-106
香檳酒桶
底座Ø143x120
Ø225xH290



NO:190B
錘點賓治盤/冰盤
8" Ø 220 × H135 (mm)
10" Ø 265 × H185 (mm)
12" Ø 310 × H200 (mm)
14" Ø 370 × H230 (mm)



NO:190E
錘點香檳酒桶
Ø208 × H168 (mm)



NO:190F
香檳酒桶
Ø268 × H245 (mm)



NO:190C
光身賓治盤/冰盤
8" Ø 220 × H135 (mm)
10" Ø 265 × H185 (mm)
12" Ø 310 × H200 (mm)
14" Ø 370 × H230 (mm)



NO:190G
錘點冰酒桶
Ø 200 × H135 (mm)



NO:191A
雙龍酒座
DOUBLE DRAGON WINE STAND
L280 × W105 × H134 (mm)

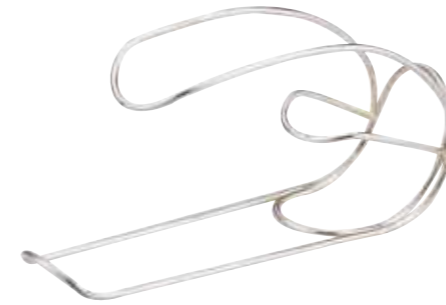

NO:191B
臥式酒架
BOTTLE STAND
L310 × W90 × H150 (mm)



NO:191C
立式酒架
BOTTLE STAND
L180 × W60 × H220 (mm)



NO:191D
酒籃
WINE BASKET
L254 × W90 × H250 (mm)





青銅鍛壓就是質量的保證







NO:199A
五頭花通洋燭臺
CANDLE STAND (5HEAD)

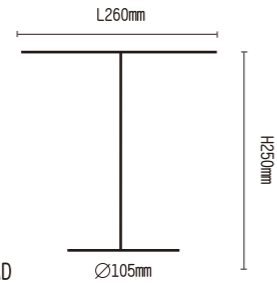

NO:199L
皇室九頭洋燭臺
CANDLE STAND (9HEADS)

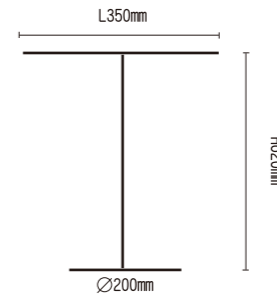

H620mm



NO:199B
四頭花通洋燭臺
CANDLE STAND (4HEADS)
L260 × H245mm



NO:199C
三頭花通洋燭臺
CANDLE STAND (3HEADS)
L260 × H245mm



NO:199D
三頭洋燭臺
CANDLE STAND (3HEADS)
W268 × H287mm



NO:199M
夢巴黎九頭洋燭臺
CANDLE STAND (9HEADS)

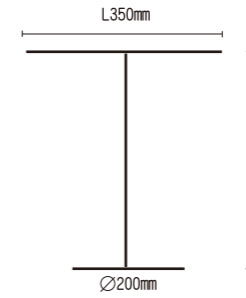

NO:199N
豪爵九頭洋燭臺
CANDLE STAND (9HEADS)

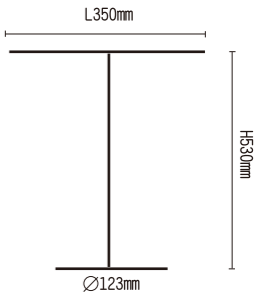

NO:199E
單頭花通洋燭臺
CANDLE STAND (1HEAD)
H216mm



NO:199F
單頭洋燭臺
CANDLE STAND (1HEAD)
H234mm



NO:199G
單頭腰形洋燭臺
CANDLE STAND (1HEAD)
H100mm



NO:199H
單頭竹節洋燭臺
CANDLE STAND (1HEAD)
H139mm



NO:199I
魚形洋燭臺
CANDLE STAND (1HEAD)
H115mm



NO:199J
花座洋燭臺
CANDLE STAND (1HEAD)
H77mm



NO:199K
光座洋燭臺
CANDLE STAND (1HEAD)
H65mm



NO:199O
五頭彩石洋燭臺
CANDLE STAND (5HEADS)

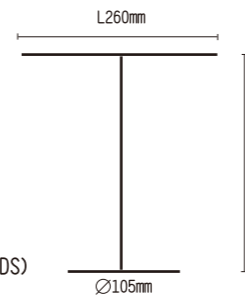

NO:199P
三頭彩石洋燭臺
CANDLE STAND (3HEADS)

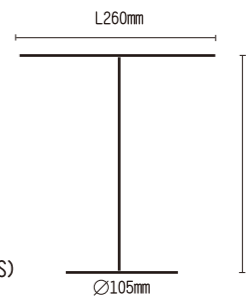

NO:199Q
單頭彩石洋燭臺
CANDLE STAND (1HEAD)
H216 (mm)

H245mm

H245mm

H245mm



NO:200A
圓形高莊碟座/果盤

編號 CODE	圓形高莊碟座/果盤	∅ (mm)	H (mm)
A1	8"	208	100
A2	9"	240	100
A3	10"	255	100
A4	10- $\frac{3}{4}$ "	275	100
A5	11- $\frac{1}{2}$ "	293	100
A6	13"	330	100
A7	15"	405	100
A8	17"	432	100
A9	18"	442	100
A10	20"	510	100



NO:200C
兩層蛋糕架
L266 × H450 (mm)



NO:200D
三層蛋糕架
L340 × H430 (mm)



NO:M-115
不銹鋼圓形食物展示架
L340xW90xH380



NO:M-119
不銹鋼橢圓食物展示架
W330xH415



NO:M-127
L203xW210xH515



H-122
蛋糕座
∅320xH60



NO:200J
錘點糕點座
小: ∅167 × H100 (mm)
大: ∅267 × H145 (mm)



NO:200K
三層糕點座
∅115-∅160-∅215-H450 (mm)



NO:200L
錘點三層糕點座
∅115-∅160-∅215-H450 (mm)



NO:200M
二層糕點座
∅260-∅325-H320 (mm)



NO:200N
錘點二層糕點座
∅260-∅325-H320 (mm)



NO:200 O
三層糕點座
∅160-∅250-∅330-H325 (mm)



NO:200P
錘點三層糕點座
∅160-∅250-∅330-H325 (mm)





NO:201A
帶蓋果仁盒
Ø117 × H94 (mm)



NO:201F
魚形醬汁架/玻璃兜
L140 × H100 × Ø 60 (mm)



NO:202A
醬瓶
H120 (mm)



NO:202B
汁更座
L110 × H60 (mm)



NO:202C
汁門
L200 × H72 (mm)



NO:201B
彎形果仁盒連架
W192 × H212 (mm)



NO:201G
光身醬汁架連玻璃兜
L140 × H100 × Ø 60 (mm)



NO:202D
牛油碟 (珠邊)
Ø 92 (mm)



NO:202E
牛油碟 (綫條)
Ø 92 (mm)



NO:201C
直身果仁盒連架
W161 × H260 (mm)



NO:201H
三頭醬汁架
W138 × H99 (mm)



NO:203A
牙簽盒
L110 × W40 × H22 (mm)



NO:203B
錘點牙簽盒
L110 × W40 × H22 (mm)



NO:201D
三頭果仁架
W160 × H220 (mm)



NO:201I
三兜醬汁座
L231 × W80 (mm)



NO:204A
胡椒瓶/鹽瓶
Ø 38 × H82 (mm)



NO:204B
胡椒瓶/鹽瓶
Ø 47 × H75 (mm)



NO:205A
帶蓋竹節牙簽筒
Ø 32 × H90 (mm)



NO:205C
竹節牙簽筒
Ø 30 × H60 (mm)



NO:205D
杯形牙簽筒
Ø 38 × H70 (mm)



NO:201E
兩頭果仁盒連架
W247 × H162 (mm)



NO:206B
錐形細花瓶
∅85 × ∅185 × H145 (mm)

NO:206A
錐形大花瓶
∅105-∅280-H242 (mm)



NO:206D
錘點花盆座
∅200 × H103 (mm)



NO:206E
花盆座
∅200-H103 (mm)



P-128
L82xH160



NO:206F
直身花瓶
H181 (mm)



NO:206G
梨形花瓶
H175 (mm)



NO:206H
錘點花盆
L250 × H195 (mm)



NO:207A
單綫圓形
∅41 × W32 (mm)



NO:207B
雙綫圓形
∅47 × W30 (mm)



NO:207C
通花
∅45 × W40 (mm)



NO:207E
間金
∅45 × W25 (mm)



NO:207F
三瓣梅
∅42 × W35 (mm)



NO:207G
四瓣梅
∅44 × W35 (mm)



NO:207H
六瓣梅
∅44 × W35 (mm)



NO:207I
五瓣梅
∅44 × W35 (mm)



NO:207J
菊花
∅41 × W28 (mm)



NO:N-128
旋形
∅58xW45



NO:207L
棱形
L50 × W30 (mm)



NO:207 O
金絲結
L55 × W28 (mm)



NO:207R
彩石
∅48 × W45 (mm)



NO:207S
彈簧形
∅46 × W33 (mm)



NO:207T
星形
∅58 × W45 (mm)



NO:207U
錘點
∅50 × W25 (mm)



NO:207V
蟹爪形
∅60 × W32 (mm)



NO:207W
厚裝鼓形(錘點)
∅40 × W32 (mm)



NO:207X
厚裝鼓形
∅40 × W32 (mm)



NO:207Y
錘點雙綫圓形
∅50 × W25 (mm)



NO:208A
圓形烟灰碟
Ø 98 × H12 (mm)



NO:208B
圓形烟灰碟 (深莊)
Ø 113 × H25 (mm)



NO:208C
方形烟灰碟
L106 × W106 (mm)



NO:208D
錘點方形烟灰碟
L106 × W106 (mm)



NO:208E
鼓形烟灰盅
Ø 100 × H40 (mm)



NO:208F
圓形烟灰盅
Ø 126 × H31 (mm)



NO:208G
錘點烟灰盅
Ø 126 × H31 (mm)



NO:208H
鼓形烟灰盅
Ø 137 × H43 (mm)



NO:208I
鑄造烟灰盅
Ø 83 (mm)



NO:208J
三頭龍烟灰盅
Ø 118 × H28 (mm)



NO:208K
雪茄座
Ø 55 × H120 (mm)



NO:208L
雪茄烟灰盅
Ø 80 × L125 × H52 (mm)



NO:208M
魚形烟灰盅
Ø 126 × H121 (mm)



NO:208N
烟灰盅連火柴座
Ø 114 × L135 × W154 (mm)



NO:208 O
3"烟灰盅連底碟 (Ø96mm)
4"烟灰盅連底碟 (Ø132mm)



NO:208P
5"烟灰盅連底碟 (Ø113mm)



NO:208Q
6"烟灰盅連底碟 (Ø190mm)



NO:214A
蛋形自助餐盤
L500 × W325 (mm)



NO:214B
蛋形自助餐盤
L500 × W325 (mm)



NO:214C
圓形自助餐盤
Ø 305 × Ø 205 (mm)
Ø 360 × Ø 320 (mm)
Ø 380 × Ø 330 (mm)



NO:214D
洋花邊圓盤
Ø 305 × Ø 205 (mm)
Ø 360 × Ø 320 (mm)
Ø 380 × Ø 330 (mm)



NO:214E
錘點圓形自助餐盤
Ø 305 × Ø 205 (mm)
Ø 360 × Ø 320 (mm)
Ø 380 × Ø 330 (mm)



NO:214F
方形自助餐盤 (錘點)
小: L490 × H390 (mm)
大: L585 × H432 (mm)



NO:214G
方形自助餐盤 (玫瑰邊)
小: L490 × W390 (mm)
大: L585 × W432 (mm)



NO:214H
方形自助餐盤
小: L490 × W390 (mm)
大: L585 × W432 (mm)



NO:209A
茶杯托 \varnothing 75 × H42 (mm)
茶杯底碟 \varnothing 139 (mm)
骨瓷茶杯 \varnothing 75 (mm)

NO:209B
錘點茶壺
 \varnothing 140 × H160



NO:212
三文魚
A: L600 × H140 (mm)
B: L900 × H190 (mm)



R-101
通花杯托
1cm
 \varnothing 68xH125

NO:209D
茶隔連座
 \varnothing 62 × L140 (mm)

NO:209E
錘點杯托
 \varnothing 65 × H96 (mm)

NO:209G
杯蓋

NO:209F
光身杯托
 \varnothing 65 × H96 (mm)

可按客户要求訂制此系列



NO:213A
蛋形面包籃
L275 × W195 × H67 (mm)

NO:213B
圓形面包籃
 \varnothing 230 × H65 (mm)



NO:210
啤酒杯
 \varnothing 97 × H132

NO:211A
方形紙巾盒
L140 × W140 × H140 (mm)



0-104
不銹鋼紙巾座
L150xW150xH150



NO:213C
面包架
 \varnothing 182 × H135 (mm)

NO:213D
面包架
L119 × W93 × H140 (mm)



尺寸可按要求訂制



NO:215A
海鮮塔 (無邊)
SEAFOOD PLATTER-4TIERS
Ø400-Ø350-Ø300-Ø250 × 770 (mm)



NO:215B
海鮮塔 (齒邊)
SEAFOOD PLATTER-3TIERS
Ø350-Ø300-Ø250 × H670 (mm)



NO:216A
奶壺
MILK POT WITH PEARI EDGE
小:L14 × H13 (cm)
大:L17.5 × H18 (cm)



NO:216B
咖啡壺
COFFEE POT WITH PEARL EDGE
小:L17.5 × H13 (cm)
大:L24 × H18 (cm)



NO:216C
奶盅
MILK POT
小:L15 × H6.5 (cm)



NO:216D
糖盅
SUGAR JAR WITH PEARL EDGE
小:L12 × H9.2 (cm)
大:L15 × H11.2 (cm)



NO:M-101
奶壺:L54xW36xH40
NO:M-102
啡更:L210
NO:M-103
咖啡壺:L180xW82xH195
NO:M-104
托盆:L330xW270xH25

夜總會KTV包房設計系列, 可按客戶的要求開發設計



NO:225E
果盤架
L390 × W390 × H110 (mm)



NO:225F
冰桶
內徑:Ø130
L213 × W213 × H150 (mm)



NO:225D
水果叉筒
內徑:Ø50
L110 × W110 × H110 (mm)



NO:117U
毛巾碟
L174 × W72 × H35 (mm)



NO:225C
牙籤筒
內徑:Ø40
L100 × W100 × H70 (mm)



NO:225A
紙巾盒
L340 × W200 × H70 (mm)



NO:225B
話筒座
L280 × W170 × H100 (mm)

產品研發部



CNC模具房





NO:160G 蟹剪 L185mm

仿古餐具系列



Q-109
九孔烟盅
表面效果金、銀、古



Q-110
烟盅
表面效果金、銀、古



蟹具組合



以上產品可參照鍍金銀圖片

尺寸如有變動、錯漏按實報為準

香港順誠五金金銀器制品廠
銀器保養

- 防止銀器變黑:含硫的腐蝕介質與銀器直接接觸是引起銀器表面變色的主要原因。由于空氣,某些食品中含有硫化物(蔬菜、蛋類等)因此,銀器在使用后,必須盡早清洗,以免硫化(俗稱氧化)。
- 銀器去黑:選用正當的銀器浸泡劑在洗盤墊上若干鉛薄、鉛格或鉛柵,使銀器可直接接觸到鉛,浸泡10分鐘,電解作用可去除污點且不會影響含銀量(注意銀器不粘有油脂時才有效)或將銀器放置于濃食鹽水中浸泡數分鐘即可。
- 銀器擦亮:用潤濕海绵或布(全綿)塗上擦銀膏,擦磨銀器,然後過水并用軟布擦干,如有必要清洗海绵并重複以上步驟,達致光亮效果(此種方法最有效)。
- 銀器的日常清洗:用溫水中性優質洗潔精清洗,再用清水過干淨,切記,金銀器產品均不能用漂水強碱強酸,去污物等化學藥劑漂洗及硬質物品碰擦。
- 銀器的維護:銀器保管對保護其美觀與清洗一樣重要,銀器不能堆放,擦干的銀器要放在沒有含硫和烟氣的房間內,(遠離暖氣)存放在沒有硫和木料的塑料容器內,一個容器一件銀器。每天使用后放在塑料碗籃內,避免接觸硬物體,防止腐蝕表面。
- 金器去污可用七姐粉帶濕潤輕柔擦磨即可。

金銀器皿配置瓷器規格參照表

編號	產品名稱	適用瓷器	適用菜蓋	內實際尺寸	外實際尺寸
146A	11"鮑魚窩	8"瓦碟		200mm	270mm
146B	12"鮑魚窩	9"瓦碟		226mm	300mm
146C	13"鮑魚窩	10"瓦碟		257mm	330mm
134B	11"旦形碟座	9"瓦旦碟	配10"旦蓋	210mm/150mm	280mm/218mm
134C	13"旦形碟座	10"瓦旦碟	配12"旦蓋	260mm/178mm	326mm/245mm
134D	15"旦形碟座	12"瓦旦碟	配14"旦蓋	305mm/225mm	382mm/300mm
134E	17"旦形碟座	14"瓦旦碟	配16"旦蓋	360mm/265mm	434mm/340mm
134F	20"旦形碟座	16"瓦旦碟	配18"旦蓋	420mm/300mm	505mm/390mm
134G	22"旦形碟座	18"瓦旦碟		465mm/345mm	567mm/445mm
130A	8"三脚圓形碟座	7"瓦圓碟	配6-1/2"圓蓋	165mm	212mm
130B	9"三脚圓形碟座	7-1/2"瓦圓碟	配7-1/2"圓蓋	185mm	230mm
130C	10"三脚圓形碟座	8-1/2"瓦圓碟	配8-1/2"圓蓋	212mm	255mm
130D	11-1/2"三脚圓形碟座	10"瓦圓碟	配10-1/2"圓蓋	236mm	293mm
130E	13"三脚圓形碟座	10"瓦圓碟	配11"圓蓋	260mm	328mm
130F	15"三脚圓形碟座	12"瓦圓碟	配13"圓蓋	320mm	382mm
130G	17"三脚圓形碟座	12"瓦圓碟	配15"圓蓋	305mm	420mm
130H	18"三脚圓形碟座	14"瓦圓碟	配15"圓蓋	364mm	460mm
130I	20"三脚圓形碟座	16"瓦圓碟	配17"圓蓋	415mm	506mm
135A	7"×8"旦形碟托	7"/8"瓦旦碟	配7"/8"旦蓋	195mm/155mm	215mm/170mm
135B	9"×10"旦形碟托	9"/10"瓦旦碟	配9"/10"旦蓋	235mm/170mm	250mm/190mm
135C	10"×12"旦形碟托	10"/12"瓦旦碟	配10"/12"旦蓋	275mm/185mm	290mm/210mm
135D	12"×14"旦形碟托	12"/14"瓦旦碟	配12"/14"旦蓋	330mm/230mm	360mm/250mm
135E	14"×16"旦形碟托	14"/16"瓦旦碟	配14"/16"旦蓋	370mm/240mm	390mm/265mm
131A	7"×8"圓形碟托	7"/8"瓦圓碟	配6-7/2"圓蓋	200mm	220mm
131B	9"×10"圓形碟托	9"/10"瓦圓碟	配8-9 ^{1/2} "圓蓋	220mm	245mm
131C	10"×12"圓形碟托	10"/12"瓦圓碟	配9-11 ^{1/2} "圓蓋	255mm	275mm
131D	12"×14"圓形碟托	12"/14"瓦圓碟	配11-13 ^{1/2} "圓蓋	280mm	310mm
131E	14"×16"圓形碟托	14"/16"瓦圓碟	配13-15 ^{1/2} "圓蓋	365mm	385mm